

Better Homes and Gardens®

The Handcrafted
Home
SPECIAL ISSUE

WOOD

April 2001 ISSUE 132

www.woodonline.com®



family room **renovation**

you can do it... our guide
makes it easy

featuring ■ solid-wood paneling
■ built-in bookcases ■ arts & crafts wall sconces

Display until April 3, 2001



Don't just dream it Do it!

Woodworkers, by nature, are dreamers. While taking satisfaction in what we've already made, we envision all of the great projects yet to emerge from our workshops. We fantasize about completing every item on our to-do list. We look around our homes and shops, and ponder possible improvements, all the time making mental sketches to sleep on.

More often than not, we have a general idea of how to make these improvements, but the details may escape us. We know, for

example, that many of the rooms in our homes would look and function a lot better with a woodworking facelift. But, how do we get started?

Well, beginning with this issue, help is on the way. We've developed a new series of articles dubbed "The Handcrafted Home" in response to your requests for information on enhancing your homes through woodworking. We introduced this new concept to you back in the February issue with the unveiling of a super-handy laundry center. Here, beginning on page 46, we're thrilled to bring you the first large-scale effort in this fresh editorial initiative—a floor-to-ceiling woodworking renovation of a family room. I think you'll be impressed. And hopefully, you'll come away with lots of great ideas.

My hat is off to the entire staff for shouldering this ambitious undertaking with such breathtaking results. Special thanks go to the two guys pictured above, who saw every step of the project through to its completion.

May our efforts inspire and aid you in turning your home into The Handcrafted Home. Now, go ahead—make your woodworking dreams come true.

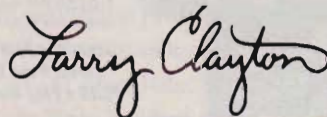

Staff members Bill Krier, left, and Jim Downing look over plans for the family-room renovation featured in this issue.

Customer Service Information: For service on your subscription, including change of address, contact www.wood-magazine.com/service or call 800/374-9663. **Subscription mailing address:** Better Homes and Gardens WOOD magazine, P.O. Box 37439, Boone, IA 50037-0439. Please enclose your address label from a recent issue. **Editorial mailing address:** The Editor, WOOD magazine, 1716 Locust Street, GA310, Des Moines, IA 50309-3023. For questions for our editorial staff, questions about how to reach an advertiser, or to place an advertisement in our magazine call 800/374-9663. **To order back issues call 800/346-9663.** For article reprints, write to the editorial address and enclose \$5 per article.

Editor **LARRY CLAYTON**
Managing Editor **JIM HARROLD**
Assistant Managing Editor/Features **PETER J. STEPHANO**
Senior Design Editor **JAMES R. DOWNING**
Projects Editor **BILL KRIER**
Projects Editor **JAN HALE SVEC**
Products Editor **DAVE CAMPBELL**
Techniques Editor **JIM POLLOCK**
Shop Manager/Project Designer **CHARLES I. HEDLUND**
Assistant Design Editor/Project Builder **KEVIN BOYLE**
Production/Office Manager **MARGARET CLOSER**
Administrative Assistant **SHERYL MUNYON**
Reader-Contact Specialist **BEN VONRUDEN**
Illustrators **KIM DOWNING, LORNA JOHNSON, ROXANNE LEMOINE, ERICH LAGE**
Contributing Photographers **MARTY BALDWIN, DOUG E. SMITH**
Technical Consultant **DAVE HENDERSON**
Contributing Craftsman **JIM HEAVEY**

Creative Director **DANIEL MASINI**
Associate Art Director **JOHN MEEK**
Assistant Art Director **CHERYL A. CIBULA**
Art Department Assistant **VICKIE JANSSEN**

Publisher **MARK HAGEN**
Ancillary Sales and Internet Manager **MARLEN KEMMET**

Advertising Office: 333 N. Michigan Ave., Suite 1500,
Chicago, IL 60601 Phone: 312/853-2890 FAX: 312/580-7906
Direct Response Advertising **CAROLYN DAKIS**
Account Executive **RON GOLMINAS**
Account Executive **NEIL KIRBY**
Advertising Manager **JIM HUGHES**
Marketing Manager **GERALLIE LEGASPI**
Sales Assistant **MARGARET TRAVIS**
Sales Assistant **THERESA COOKS**

Publishing Director **WILLIAM R. REED**
Associate Business Director **CRAIG FEAR**
Senior Product Manager **RICK GROW**
Advertising Services Manager **PAT HENDERSHOTT**
Consumer Marketing Director **LIZ BREDESON**
Consumer Marketing Manager **DAVE HONOLD**

Vice President Publishing Director **JERRY WARD**

MEREDITH PUBLISHING GROUP
President **STEPHEN M. LACY**
Magazine Group President **JERRY KAPLAN**
Group Sales **MICHAEL BROWNSTEIN**
Creative Services **ELLEN DELATHOUDER**
Manufacturing **BRUCE HESTON**
Consumer Marketing **KARLA JEFFRIES**
Operations **DEAN PIETERS**
Finance and Administration **MAX RUNCIMAN**



WILLIAM T. KERR, President and Chief Executive Officer
E.T. MEREDITH III, Chairman of the Executive Committee

©Copyright Meredith Corporation 2001
All rights reserved. Printed in the U.S.A.

Better Homes and Gardens® WOOD® magazine (ISSN-0743-894X) is published nine times a year in February, March, April, May/June, July/August, September, October, November, and December by Meredith Corporation, 1716 Locust St., Des Moines, IA 50309-3023. Periodicals postage paid at Des Moines, Iowa, and additional mailing offices. Better Homes and Gardens trademark registered in Canada and Australia. Marca Registrada en México. **ONE-YEAR SUBSCRIPTION PRICES:** U.S. and its possessions, \$27; Canada, \$39; other countries, \$47. Canada Post Publications Mail Sales Product Agreement No. 1369350. Canadian BN 12348 2887RT. **CANADIAN RETURN ADDRESS:** Better Homes and Gardens WOOD magazine, 2744 Edna Street, Windsor, Ontario, N8Y 1V2. **POSTMASTER:** Send address changes to Better Homes and Gardens WOOD magazine, P.O. Box 37439, Boone, IA 50037-0439.



contents

WOOD® magazine

April 2001, Issue 132

projects & techniques

special section

46 family room renovation

Transform an ordinary room into something extraordinary. We'll show you how.

52 installing traditional wall paneling

Our illustrated guide takes you step by step through the process from planning to completion.

60 built-in bookcase

Learn how to size, construct, and install handsome wall cabinets that fit your remodeling plan.

66 Arts & Crafts wall sconces

Save money on a high-end, mica-paneled, light fixture by using our cost-effective kit.

80 pivoting picture frames

Discover a new way to mount and display your favorite photos...twice.

86 desert dustbin

Build this easy scrollsawn project in just an evening or two.

The Handcrafted Home

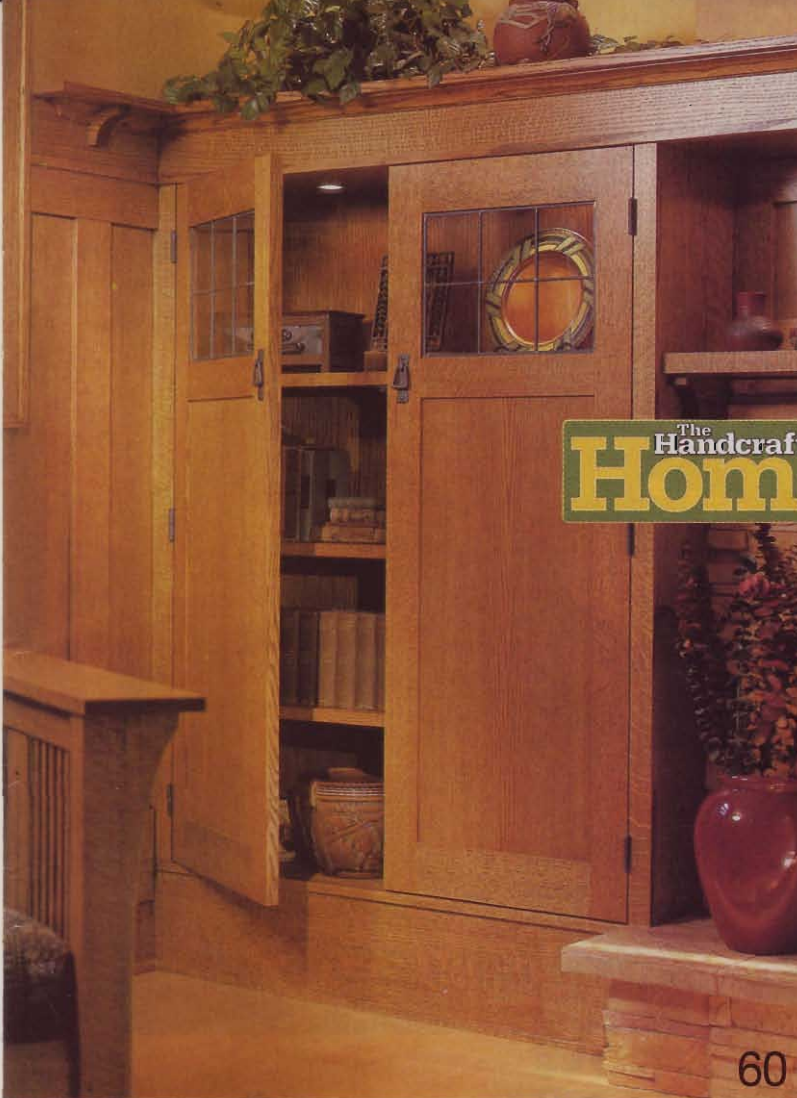

features

72 a history of the Arts & Crafts movement

See how this design trend resulted in a practical style of popular furniture.

88 carving a niche in Vermont

Meet a woodworker whose carving talent lets him raise his furniture design to a new artistic level.



contents

April 2001, Issue 132

tools & materials

74 compact air compressors

We test seven models, all 2-hp and priced under \$350.

84 water-based finishes

Discover the advantages of these coatings, and learn application tips that guarantee great results.

departments

14 talking shop

How to successfully finish red oak.

16 business side of woodworking

Make a tidy retirement income with your workshop skills.

18 great ideas for your shop

Locate cabinet door hinges precisely with this fail-safe jig.

22 be our guest experts

Router gurus Bob and Rick Rosendahl talk tool use and safety.

24 furniture repair shop

Fix a wobbly chair in five easy steps.

26 router-bit review

Use spiral bits for clean, straight cuts.

43 the story of wood

Here's what's what in wood products.

110 wood anecdote

Few species serve as many needs as northwest giant Sitka spruce.



74



26

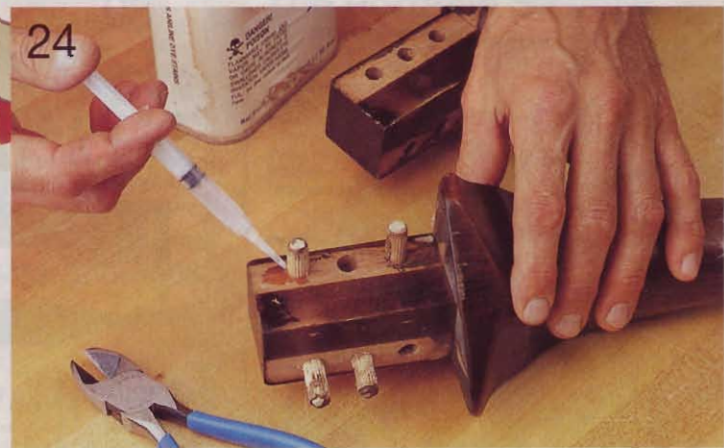

24



6

in every issue

- | | |
|---------------------------------|---------------------------|
| 2 the editor's angle | 94 wood forum |
| 8 talking back | 100 products that perform |
| 12 WOOD ONLINE® | 112 finishing touches |
| 28 tips from your shop and ours | |

Cover photograph: Wm. Hopkins

Letters, Comments & Updates

Easy fix for tablesaw tilt

Your review of mid-priced tablesaws in Issue 128 mentions that saws whose tilt mechanisms are attached to their stamped-steel housings lack a positive feel when adjusted to their 90° and 45° bevel stops. This is because the housing deflects easily, allowing you to turn the handwheel well beyond the stops.

I solved this problem on my 10-year-old Craftsman tablesaw by reinforcing the cabinet side with a piece of 3/4" ply-

Older Craftsman saw
(viewed from inside, trunion not shown)

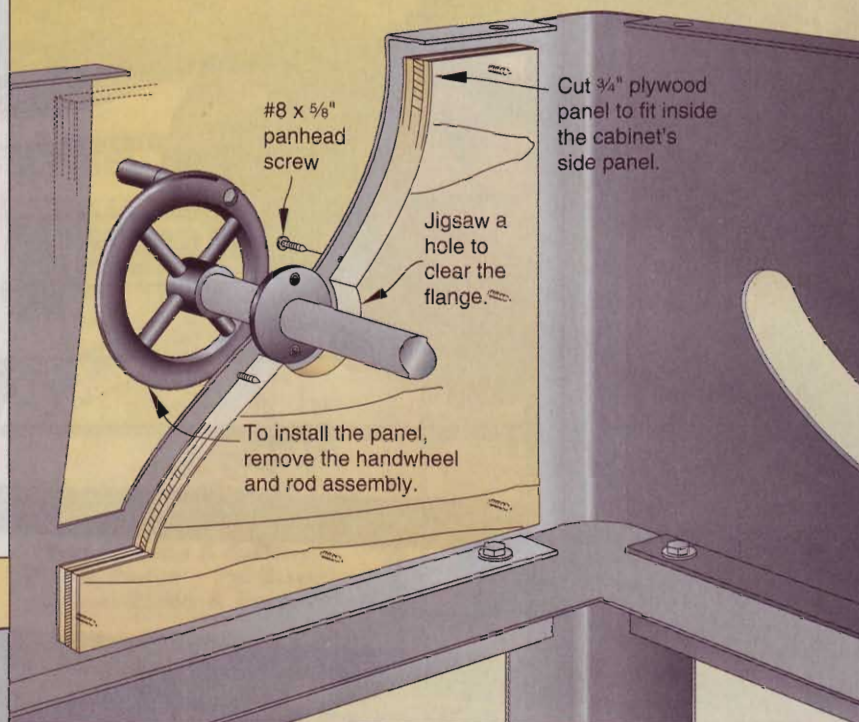

Newer Craftsman and Ridgid saws
(viewed from inside, trunion not shown)

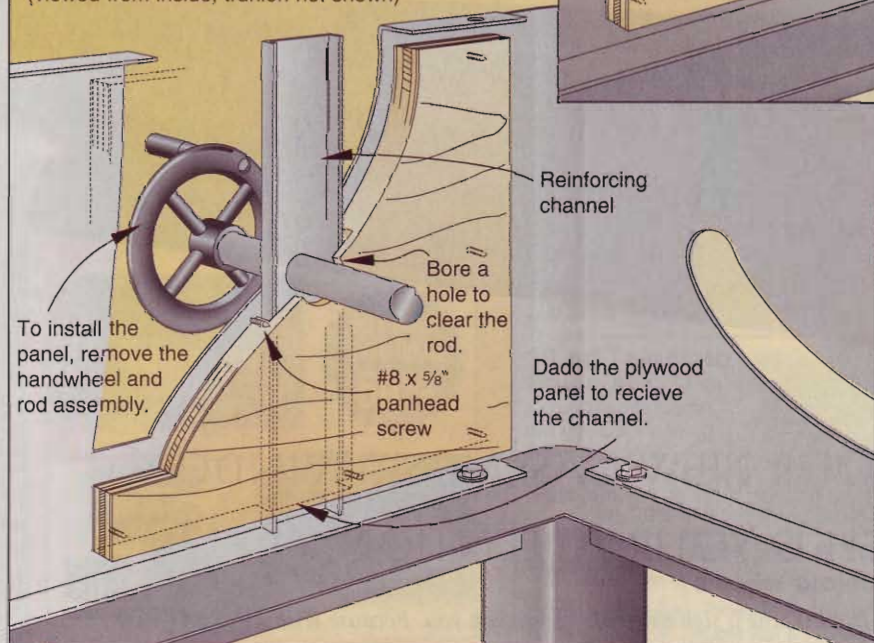

wood. Just remove the threaded rod, cut the plywood to fit inside the cabinet, and cut a hole large enough to clear the flange that houses the shaft nut. Drill holes through the housing, and fasten the plywood in place with sheet-metal screws, as shown in the

drawing. You'll be surprised at the improved stiffness.

—Wynn Richardson, Greenwell Springs, La.

You'll be interested to know, Wynn, that both Craftsman and Ridgid must be aware of this problem. The newer

Craftsman saws and all the Ridgid ones have a steel channel inside the housing that greatly reduces the flexibility of the cabinet side. However, even their performance can be improved by the addition of a plywood panel, as shown.

Use better technique on the compute

The photo on page 62 of Issue 128, showing the turning of the compute's bowl is printed backwards. In addition, the gouge is shown being used straight on as a scraper. This produces a rough surface, and dulls the tool quickly.

Instead, the gouge should approach at an angle from the side, riding on its bevel. This produces a smooth finish, with less sanding and less tool sharpening.

—Carl Schneider, Boca Raton, Fla.

Continued on page 10

PAINTING POINTERS



Brought to you by
THE HOME DEPOT®
First In Home Improvement™

Brushing Up

Ready to brighten up the place with a new coat of paint? Devote the same care to choosing your brushes as you do to picking your paint.



Many people get confused about which bristle material to use for various paints.

Here's an easy way to remember: you've seen your hair absorb moisture and turn frizzy in humid weather. **NATURAL-BRISTLE BRUSHES** behave the same way in water, which is the base of latex paint. A frizzy brush does a bad job, so save natural bristles for oil-based varnishes and paints.

For latex paint, you need synthetic bristles, like nylon or polyester. Some **SYNTHETIC BRUSHES** work for both water-based and oil-based paint, but be very careful switching finishes with the same brush. Unless you clean the brush very thoroughly, you'll contaminate your paint and spoil the finish. Avoid this problem the way serious painters do: buy parallel sets of brushes, keeping one set for water-based finishes only. A little care in choosing a brush will make your job—and your finish—a lot smoother.



For more information, consult the professionals at The Home Depot.

The Home Depot is not affiliated with Toyota. The Home Depot is a registered trademark of Home Depot, Inc.

Sponsored by
TOYOTA TUNDRA

Win a Tundra!
See facing page for details.



talking back

Forming the float plane propeller

When it came to forming the propeller for the toy floatplane in Issue 127, I was apprehensive about two things: keeping the thin blank standing upright on the tilted bandsaw table and the proximity of my fingers to the blade.

I drilled the $\frac{5}{16}$ " center hole first, then used a flathead screw and washer to fasten the blank to a $\frac{3}{4}$ "x1x7" scrap. Now I can simply make the first cut indicated on the pattern, as shown, flip the assembly end-for-end, and make the second cut. Then I remove the blank, reverse and refasten it, and make the last two cuts as before.

—Bert Wilkinson, Rochester, N.Y.



Copying the **WOOD PATTERNS®** insert

The project instructions in **WOOD®** magazine often tell me to make a copy of the pattern from the center insert. When I go to the copy store, I'm told that they can't copy the pattern because of the copyright mark. What am I to do?

—Kent Madsen, Mesa, Ariz.



Sorry, Kent, for the collision of copyright with convenience. Starting with the last issue, language was added on the title block of the pattern insert to end the problem.

© Copyright Meredith Corporation, 2001. All rights reserved. Printed in the U.S.A. Meredith Corp., the publisher of **WOOD PATTERNS®**, allows the purchaser of this pattern insert to photocopy these patterns solely for his/her own personal use. Any other reproduction of these patterns is strictly prohibited.

Same saw, different number

Sometime after we fact-checked the article on mid-priced tablesaws in Issue 128, Delta changed the model number of the 36-475 saw we tested. The new number is 36-477.

Write Us!

We welcome your comments, criticisms, suggestions, and yes, even compliments. Please write to: **Talking Back, WOOD Magazine, 1716 Locust St., GA310, Des Moines, IA 50309-3023.** We select and publish only letters of the greatest benefit to our readers.

www.woodonline.com

Visit our online woodworking show for **shop pointers galore**

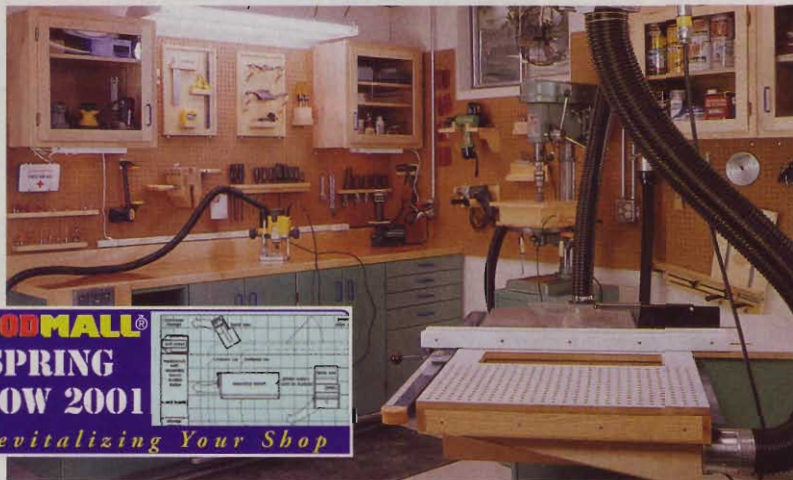

If you have a workshop, you don't want to miss the WOODMALL® Spring Show 2001—Revitalizing Your Shop. This latest (and possibly greatest) show opens at noon (CST) on Friday, March 23, and closes at midnight on Monday, April 2. Show sections include:

- A tool sweepstakes.
- Free downloadable plan for a mobile tool base.
- Announcement of a top-shop contest.
- Seminars on such topics as dust-collection basics and tuning up power tools.
- Tours of top-notch shops from around the world.
- Special pricing on discounted tools.
- Our best ideas for jigs and fixtures that help you in everyday shop tasks.
- And, a sneak peek at the newest shop we're building on the premises of WOOD® magazine headquarters.

It's all free, of course, and guaranteed to help you improve your own little corner of the woodworking universe.

Go to woodmall.com and click on the Spring Show 2001 logo.

Go online to become a better woodworker

Here's a quick, pain-free way to hone the skills vital to becoming an accomplished woodworker. Every month we offer a free, different, and informative online seminar on topics ranging from applying laminates to decorative joinery.

After taking the seminar, try it in your shop. If you still have questions, just jump into one of our numerous online discussion groups where expert woodworkers are anxious to help you out.

Go to woodmall.com and click on Free Seminar near the top of the page.

A tip every day keeps you in a woodworking way

If you love the tips section found here in WOOD magazine, visit the WOOD ONLINE Shop Tip of the Day. We bring you a new illustrated tip every day, so check back often. You can print the tips and build your own collection for quick reference.

Go to woodonline.com and click on Shop Tip of the Day.

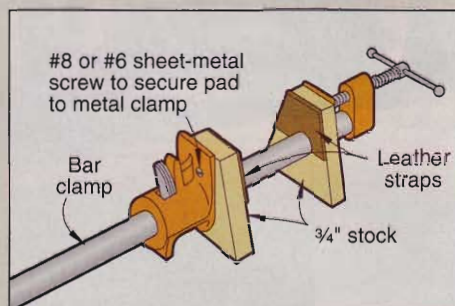

How to save lots-o-money on tools

When a manufacturer or retailer decides to drop a product from its lineup, the price on remaining inventory often goes down dramatically. Likewise, you can save big money on tools offered as "factory-reconditioned." These products are typically returns from retailers to the manufacturers. Each tool is inspected closely by the manufacturer, fixed if necessary, and offered again for sale at a lowered price.

Searching for these bargain tools can be time consuming, but not if you make a habit of visiting the online "Closeouts" area at WOODMALL. Everyday you'll find many items at reduced prices from multiple retailers. Because many items are available on a limited basis, remember to check back often.

Go to woodmagazine.com/woodmall/ and click on Closeouts near the top of the page.

how to meet, and beat, the challenges of **finishing red oak**

When choosing a finishing system for the family-room renovation featured in this issue, I knew that several challenges lay ahead. First, I needed a stain that wouldn't "bleed-back." This term refers to the tendency of some stains to soak into porous woods, such as red oak, or into the joint between a panel and frame, then bleed back out, forming unsightly dark pools on the surface. And, the stain color had to suit the Arts and Crafts look of the room.

To protect the stained surface, I wanted a tough, fast-drying clear top coat—one that I could apply quickly by brush. Of course, the finished surface had to be smooth, natural in appearance, and uniformly colored.

Well, after a series of experiments with various products and techniques, I came up with a system that meets all of those requirements. Here's how you can ensure the same quality look in your home.

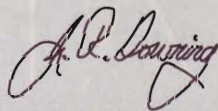

—Jim Downing, Senior Design Editor

1 Great finishes begin with good surface prep

It makes a lot of sense to sand all of the workpieces through a full succession of grits before installing them. This gives better results with much less effort compared to installing workpieces, then sanding. And, it's a lot

easier to deal with sanding dust in your shop than at the installation site.

I began by sanding all of the solid stock with a random-orbit sander, using a succession of 120-, 150-, and 180-grit discs. That was followed by a final hand-sanding with a hardwood block and 180-grit sandpaper. The plywood panels received a sanding with just the 180-grit hardwood block. I didn't want to risk sanding through the thin top ply.

After final sanding, remove any traces of sanding dust with compressed air. For health and safety purposes, I wore a dust mask, ventilated my shop, and always directed the compressed air away from me.

2 To prevent bleed-back, choose a gel stain

After installing all of the woodwork, I applied a number of stains to red-oak scraps, looking for one that gave just the coloring needed, with no bleed-back. Minwax Aged Oak Gel Stain filled the bill.

Because gel stains sit on top of a wood surface, rather than soaking into them, there's no chance of bleed-back. That seems like a simple solution, but gel stains create a new set of challenges to deal with.

Even after you apply them with a brush and wipe them off with a rag, the thick viscosity of gel stains makes them collect excessively in corners. I worked that extra stain out of tight spots with a dry brush, then went over the surface again with a clean rag to even out the coloration. I stopped from time to time to clean the dry brush with mineral spirits to maintain its effectiveness.

3 Top off the stain with a durable clear coat

Because of its durability and short time span between applications, I chose Minwax Fast-Drying Polyurethane to protect the stained surfaces. After brushing on a first coat of the gloss version of this finish, I waited 24 hours for it to dry. This time period may be longer depending on temperature and humidity—just be sure the finish cures enough to sand it off as a dry powder.

During application, position a strong light to the side of the finished surface so it casts a reflection. Use this glare to help spot runs, sags, or missed areas. I prefer a halogen work light on a stand. Repeat this inspection a half-hour after application—at that point, with the finish still workable, you should still be able to brush out imperfections.



To remove any dust nibs in the finish, and give it "bite" for holding the next coat, lightly sand the surface with a hardwood block and 180-grit abrasive. Be careful not to sand into the stain. Remove the dust with a vacuum cleaner and round-brush attachment. Follow that with a tack cloth.

Apply a final coat of satin polyurethane just as you applied the first coat. If, despite your best efforts, you wind up with runs or sags in the dried finish, sand them off carefully with a hardwood block and 220-grit sandpaper, as shown in the photo below. Then, lightly sand the panel or rail that had the imperfection, and reapply polyurethane to the entire surface, being careful to mask off adjoining pieces as shown on page 14.



For small imperfections, you don't have to reapply finish. Just sand off the run or sag as described earlier, but don't sand the entire panel or rail. Buff the sanded area with an ultra-fine woven-plastic-pad abrasive (grey-colored Scotch-Brite no. 7448 works well). Then, go over the same area with an even finer pad, such as a white Scotch-Brite no. 7445, to match the sheen of the rest of the satin surface.

4 Fill the nail holes, and you're done

Now's the best time to fill nail holes with a flexible (non-hardening) putty that matches the color of the stained wood. I used Color Putty brand in Honey Oak color. 🌲

Photographs: Baldwin Photography

ROUSSEAU CO. Quality Router Accessories

VACUUM CLAMP

Multi-Purpose Tool For Template Routing & Clamping

FREE CATALOG CALL 800-635-3416 • www.rousseauco.com

Circle No. 1272



High Performance Router from Fein

This powerful new 3¼ horsepower plunge router will cut production time and give you a superior finish. Thanks to an advanced electronic feedback circuit, this state-of-the-art router operates at a consistent torque and speed for extremely smooth operation and a cleaner edge. It's lightweight for greater control, has a wider range of speeds, and includes soft start, dust collection port, and QC spindle. The new FEIN RT-1800 is designed for the cabinetmaker, solid surface fabricator and serious hobbyist. Call 1-800-441-9878 for more information and a dealer near you, or visit us on the web at www.feinus.com.

Finishing is just the beginning

Fein Power Tools, Inc. 1030 Alcon Street
Pittsburgh, PA 15220 1-800 441-9878

Fein

live long & **prosper**

Woodworking can provide a nice retirement income, and now it won't reduce your Social Security, either

Live longer and retire earlier. It's a plan that's become something of a new version of the American dream.

Trouble is, it doesn't always square with reality. The truth is, not everyone wants to stop working at 60 or 65. And not everyone can afford to live off only Social Security or other pensions and investments for 20 or more years.

Fortunately, woodworking can be a rewarding business to operate in retirement for those who do want to step away from the daily grind, but not necessarily from work and the income associated with it. And a pending change in Social Security rules means an end to earnings caps that serve to scare some retirees away from giving it a try.

Once upon a time if you earned too much, you lost

When Tim Detweiler was laid off from a construction job in 1991 in his early sixties, he certainly wasn't interested in full retirement. So the Germantown, Ohio, man turned his hobby of making fully functional all-wood locks into a full-time occupation and a new business.

But when he became eligible for full Social Security at age 65, he faced limiting his earnings or losing \$1 in benefits for every \$3 he made above what was then a \$12,000 earnings cap. His solution was to incorporate his business, paying himself a salary equivalent to the

earnings cap plus the rest of the profits in the form of dividends, which aren't counted toward the cap.

Now, however, woodworkers won't have to bother with the expense and paperwork of setting up corporations to keep income from their retirement businesses from reducing benefits. Laws passed by both houses of Congress this spring eliminated the Social Security earnings cap, which had stood at \$17,000 for retirees ages 65 to 69. Details remain to be worked out, including a House provision that would end the earnings cap for those who retire at 64, too. But final passage and signing of the legislation is nearly certain, given the popularity of the move in an election year. (By the time you read this, it may have happened.)

The law is the final recognition that the mid-sixties is far earlier than many people want to quit work. That doesn't mean, however, that you can't leave your old job to do what you love—woodworking—and make some money at it, too.

An even better career the second time around

Joseph Ferola, a Windsor, Connecticut, craftsman, retired from his job as an

engineer with the Connecticut Department of Transportation in 1987 to become a full-time woodworker. He was still in his fifties and had a state pension to draw on.

While working, Ferola had done some spindle turning as a hobby. But in retirement he decided to try bowls. When a jury accepted one of his lathe-turned works for the Houston Festival in Texas that year, it launched a retirement career that has produced and sold more than 1,000 bowls in the four-figure range.

Because Ferola was a state employee, he wasn't in the Social Security system and never had to worry about retirement income caps. And even though he ended up doing very well financially, his interest is really in the woodturning, not the money.

"It's a beautiful thing to do in retirement," Ferola says. "I'm doing what I enjoy. It's always nice to have people pay good money for my work, and I can use it. But I still have my retirement income, so I'm not dependent on selling. If I want to, I can just relax or vacation. If I don't feel like doing anything some days, I just don't." ♦

Written by **Jack Neff**, a Batavia, Ohio, business writer and author of *How to Make Your Woodworking Pay for Itself*.



fail-safe hinge jig

transfer hinge locations
from door to carcass with
marksmanlike accuracy

Mounting hinges on an inset cabi-

net door is a straightforward process. You lay the door on your workbench, locate the hinges where you want them, and screw them in place. If they need to be mortised, you mark the outline of the hinge leaf with a knife or chisel. But how do you accurately transfer the hinge locations to the carcass or to another door? Project

builder Chuck Hedlund faced this situation not once, but four times when making the built-in bookcases featured on page 60. To solve the problem, he devised a single-use jig. Here's how to make your own.

Cut a 2 1/4"-wide, 1/4" plywood rail 3" longer than the door you are hanging, and two 3/4x2 1/4x2 1/4" plywood

stopblocks. Then cut four 1/4x3x3" plywood index blocks for each hinge. Glue and clamp the stopblocks to the rail at one end, as shown in *Drawing 1*. Now, temporarily remove the rail.

Stick small pieces of double-faced tape to the door next to the hinges. Adhere index blocks to the door, snug against the hinges, as shown on *Drawing 2*. Stick a large piece of double-faced tape to each installed index block. Now, hook one of the rail's stopblocks on the door's top edge, and press the rail onto the index blocks, as shown on

Drawing 3. Keep the rail's back edge and the index blocks' back edges flush. To make the jig usable on both right- and left-handed doors, align a second set of index blocks with the first, sandwiching the rail between them, as shown on *Drawing 4*. Carefully remove the rail and attached blocks from the

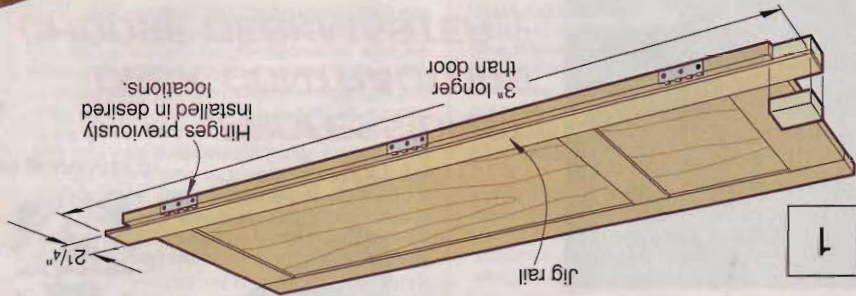

1
Hinges previously installed in desired locations.

door. Drive 1/2" wire brads from both sides to lock the squares in place. Hooking one stopblock on each door's top edge, use the jig to locate the hinges on the rest of the doors. Drill the hinge screw pilot holes.

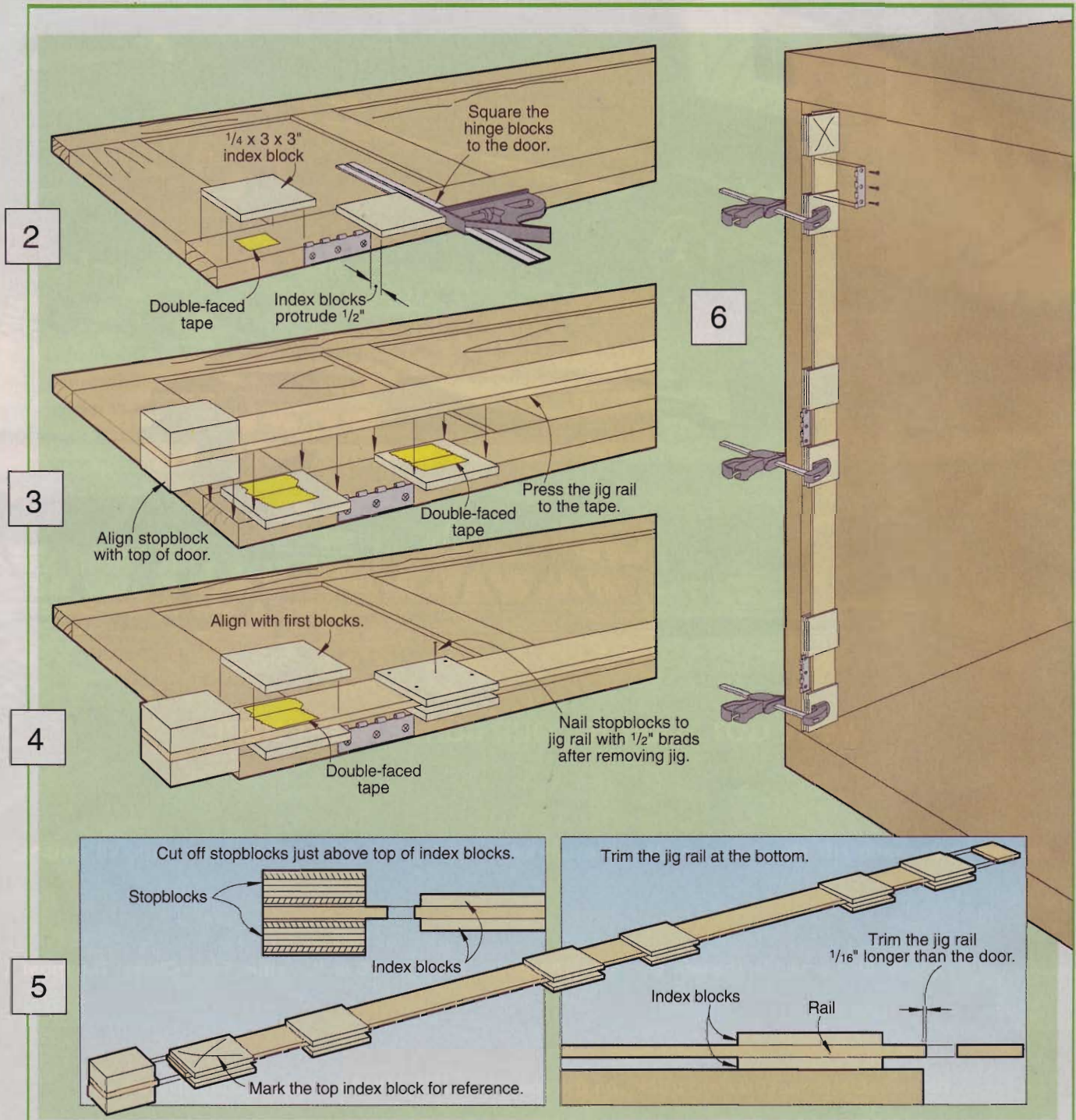

Once again, hook the jig's stopblock on a door's top edge. Mark and trim the rail to extend 1/16" beyond the door's bottom, as shown on *Drawing 5*. This extra 1/16" is the gap between the door and the carcass. Mark the jig's top end. Remove the stopblocks by cut-

ting the rail just above the top index blocks, as shown.

Now the jig is ready to position the hinges in the carcass. Simply place the jig against the inside of the cabinet with the rail's marked end up, as shown on *Drawing 6*. Clamp or use double-faced

tape to hold the jig in place. The index blocks bracket the hinges, just as they did on the doors. Position the hinges between the index blocks, and drill the screw pilot holes. ♣

Illustrations: Erich Lage; Lorna Johnson
Photograph: Baldwin Photography

Bob and Rick Rosendahl

All routers, all the time

If you watch do-it-yourself shows on public television, chances are you've seen Bob and Rick Rosendahl. At the latest count, 181 stations carry "The Router Workshop," starring this Canadian father-and-son team.

These apostles of routing started the series in 1995, and produce 26 episodes per year for PBS. They're also writing books and plan to teach woodworking classes over the internet.

Speaking of the internet—you can find more Router Workshop information, a "tip of the day," and even calculators for figuring project material requirements by logging on to www.router-workshop.com or www.pbs.org/routerworkshop.

We asked Bob and Rick to share some advice for routing beginners, and here's what they had to say.

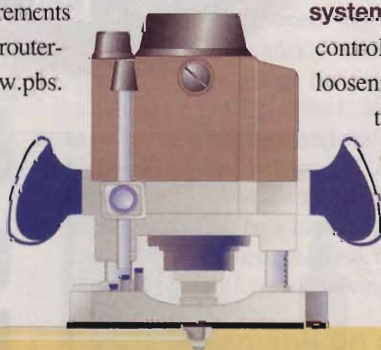

A great router has ...

- ☑ **A 15-amp motor**, which delivers the largest horsepower for a single-phase outlet, and variable-speed control.
- ☑ **A plunge base**—it's the most versatile style for both portable and stationary routing.
- ☑ **A collet that accepts 1/2" shank bits**.
- ☑ **A two-wrench collet system**, which gives you total control in the tightening and loosening process. By setting the wrenches in different positions, you "squeeze to tighten" or "squeeze to loosen." With the single-wrench system,

the wrench can damage the plunge rods when the collet breaks free. ☑ **A column lock** and a **power switch** that you can operate without releasing your grip. ☑ **An open throat**, which provides better visibility, and a base opening about 3 inches in diameter, to accept large bits. ☑ **A chuck that's threaded to the armature**. It's easily replaced if damaged.

Take the safe route

- ☑ **Always unplug your router before changing bits** or altering your setup.
- ☑ **Plan ahead before starting the router**. Keep your thinking and measuring time separate from your routing time.
- ☑ **Always wear safety glasses** and ear protection.
- ☑ **Don't use dull or damaged bits**. If a microscopic crack causes a bit to break while spinning at 20,000 rpm, pieces will fly everywhere.

Don't rout without . . .

- ☑ **Books, magazines, and videos** that provide top-quality instruction on using routers.
- ☑ **A simple router table system** that allows for safe and easy setups, bit changes, and cutting.

Bits of wisdom about bits

- 1** The Rosendahls' most used bits: 1/4" round-over bit, 5/32" Roman ogee, 3/8" straight, 3/8" rabbeting, 1/2" dovetail, and 1/2" flush trim.
- 2** Don't buy sets of bits. Buy the bit you need when you need it. Then learn all of its potential uses.
- 3** If your router collet allows it, choose 1/2" shank bits rather than 1/4". Their larger mass decreases chatter and dissipates the heat better.
- 4** For pilot-bearing bits, Bob and Rick prefer those with an allen screw, not a nut.
- 5** Avoid a single arbor with multiple, interchangeable cutters—it's too easy to set them up incorrectly.
- 6** In most cases, two-flute router bits cut better than single-flute models.
- 7** Check the surface finish of the carbide. Better quality bits will have a mirror-like finish.



"Be Our Guest Expert" gives accomplished woodworkers a chance to pass along insights about their particular areas of expertise. If you'd like to be our guest, or know someone who would, write to "Be Our Guest Expert," WOOD Magazine, 1716 Locust Street, Glenside, Pa. 19038, 610-503-6930.

surefire tactics for taking a **dowel joint apart**

To turn a wobbly chair into a sturdy one, first you have to disassemble it. Use these methods to conquer dowels that don't want to budge.

Furniture repair would be much easier if dowels worked loose at both ends at the same time. Unfortunately, they tend to stay solid at one end while wiggling at the other. So even when a chair is on the critical list, digging the dowels out for replacement usually poses a major challenge.

The photographs on this page will lead you through a useful sequence of tactics. If one method fails, move on to the next. You'll get those dowels out.

1 Break the joints apart. In many situations, you can disassemble a dowel joint with nothing more than a bar spreader and a non-marring mallet.

2 Then try drops of alcohol. If dowels remain in some holes and won't budge, try to loosen them with a few drops of alcohol. Let it soak in for a few minutes to dissolve the glue.

3 Drill a hole. If alcohol around the outside of the dowels has no effect, drill a hole into each one, and squirt alcohol inside. Wait a few minutes while it soaks through the wood, then try to yank out the dowel with pliers or side cutters.

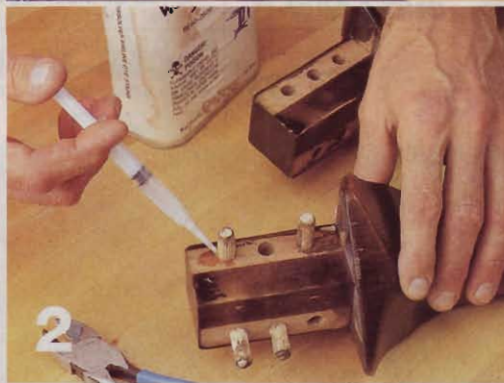

4 Add a screw. A dowel that's broken near the surface is tough to grip with pliers. So drive a small screw into the dowel, then pull it with a claw hammer.

5 Clean up the holes. After removing the dowel, take a twist drill the same diameter as the hole and turn it by hand to clean out any remaining glue or chips. You're almost certain to change the hole's shape if you use an electric drill.

You may notice that the old dowels failed because they were sitting in a little glob of glue at the very end of the hole. Let's not repeat that mistake.

Replace the old ones with fluted dowels that you've coated with glue. Daub glue all around the inside of the holes, too. You'll form a solid bond that should make the joint last a few years longer this time. 🌲

Photographs: Baldwin Photography

the shear magic of spiral bits

They look a little like the striped pole in front of a high-tech barber shop, but spiral bits do more than take a little off the top. Use them wherever you'd use a straight bit—and get cleaner cuts.

Spiral-fluted router bits leave the edges of your cuts virtually fray-free because, as they turn, the two corkscrew-shaped cutting edges stay in contact with your workpiece longer than the vertical cutting edges of a straight bit. This results in a shearing action instead of the rapid chop-chop-chop-chop of the traditional double-fluted straight bit.

Unlike most router bits that have a carbide cutter brazed to a steel bit body, spiral bits are solid carbide. Carbide, however, is harder than steel, but also more brittle, so you must work with more care than with non-carbide bits. Don't force the work, and avoid sudden plunges or starts.

Let's take a look at the three kinds of spiral bits, and how to choose the right bit for the task at hand.

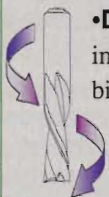

•**Downcut.** As the name implies, the cutting action of this bit is downward, or away from the router base. That shearing motion imparts a clean edge on rabbets, dados, grooves, shallow mortises, and plunge cuts in both sheet goods and solid stock.

When cutting grooves or dados deeper than the diameter of the bit, don't try to take the full depth at once. Instead, make several progressively

deeper passes. A downcut bit tends to pack the wasted material down into a deep cut, rather than ejecting it, and shallow cuts reduce the problem.

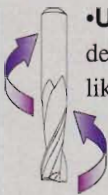

•**Upcut.** This bit wasn't designed to leave a clean edge like a downcut bit, but rather to remove the chips created in a deep plunge cut. That makes it ideal for plowing out a deep mortise in solid stock. Tear-out caused by the upward shearing will be hidden by the tenoned workpiece.

You also can use an upcut bit in your router table for any edge treatment that you perform with the workpiece face up, such as jointing solid or highly figured stock. (Remember that in a router table, the upcut bit is now cutting down.)



•**Upcut/downcut or compression bit.** The unique geometry of this bit cuts from the top down and the bottom up at the same time, and it's ideal for cleaning up the edges of hardwood plywood or melamine-coated particleboard (MCP). For such easily chipped materials, *WOOD*® magazine shop manager Chuck Hedlund first cuts the pieces oversized on the tablesaw, leaving an extra 1/16" on all sides. He then loads up a compression bit in the router table, setting the center of the bit's cutting flutes to about the middle of the workpiece's thickness. Finally, he offsets the outfeed fence 1/16" and joints away the chipped edges. ♣

Written by **Dave Campbell** with **Chuck Hedlund**
Illustrations: **Erich Lage**



Downcut

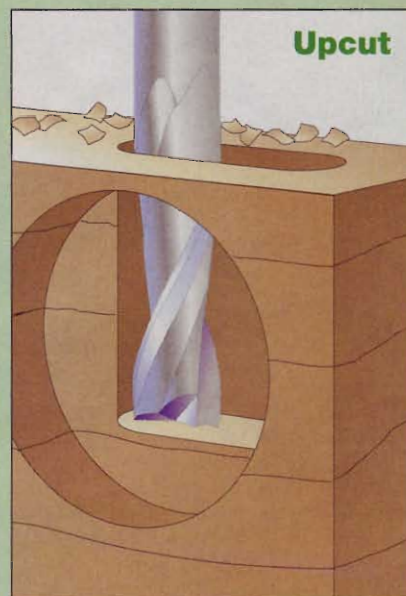

Upcut

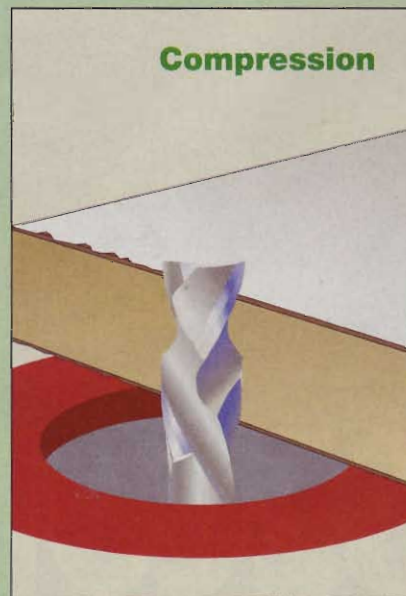

Compression



For sending in this issue's Top Shop Tip, Bob Webb receives a Freud F410 saw blade and raised-panel router-bit set (#97-204). Thanks a lot, Bob!



Top Shop Tip winner Bob Webb takes a break from his work to ponder better ways to do things in his shop.

When he's not working in the shop or noodling around with his Internet Web site, you're likely to find Bob Webb involved in a high-powered Washington think-tank. Okay, it's not Washington, D.C.; he's actually in Washington state. And the think tank is actually a hot tub

our Top Shop Tip winner enclosed with recycled lumber. "My wife Bekki and I like to just sit in there and think about stuff," Bob says. In fact, he dreamed up his award-winning tip, shown at right, pondering a shop problem while chest-deep in hot, bubbly water.

You don't need to be a deep thinker like Bob to help your fellow woodworkers. If you've come up with a solution to a shop problem, share it with us. If we like it, we'll share it with the woodworking world and reward you with \$75. The person who submits the best tip of each issue also wins a tool prize worth at least \$250. So what are you waiting for? Send us your original shop tips, along with a photo or sketch and your name, address and daytime telephone number, to:

Tips From Your Shop (And Ours)

WOOD® magazine

1716 Locust St., GA-310

Des Moines, IA 50309-3023

Or, post your tip suggestion on our Top Shop Tip discussion group at www.woodonline.com.

Because we try to print only original tips, please send your ideas only to *WOOD* magazine. Sorry, but we can't return your submissions. Thanks!

Dave Campbell

WOODWORKING PRODUCTS EDITOR



Send small parts down the exit ramp

Cutting small parts can be risky, and not just because they can disappear down your tablesaw's throat plate. They can also catch on a saw tooth and be flung at high speed toward you. To eliminate these hazards, create a zero-clearance tablesaw insert with a ramp that guides small cutoffs safely away from the blade. To use the insert properly, you'll need a simple 3/4"-thick cutoff sled, similar to the 1/2"-thick sled on page 16 of *WOOD* magazine issue 114, page 16.

First, rip the ramp and set it aside. Make a zero-clearance insert for your tablesaw, using the factory insert as a pattern. Then lower the saw blade and place the new insert in the throat opening. (Shim, if necessary, to make the insert and tabletop flush.)

Move the edge of your rip fence over a portion of the insert to hold it down, then slowly raise the running blade through the insert. Turn off the saw and lower the blade fully. Remove the insert, and glue the ramp to it where shown on the drawing at right. When the glue dries, replace the insert and repeat the blade-raising procedure. Using your crosscut sled with this insert makes small cutoffs fall safely away from your blade like slices of fresh bread.

—Bob Webb, Lake Stevens, Wash.

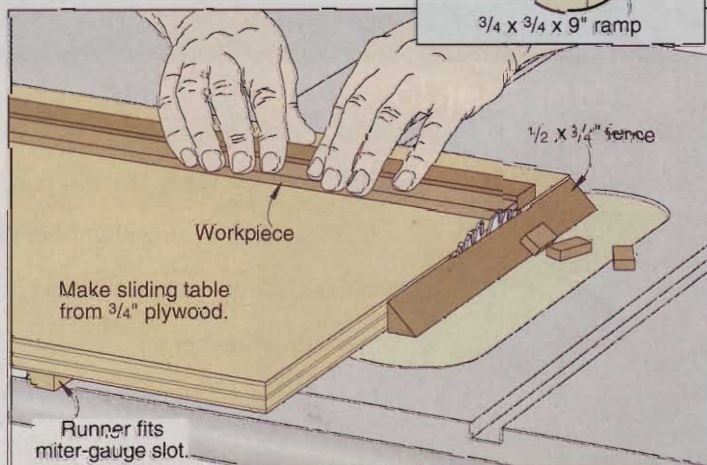
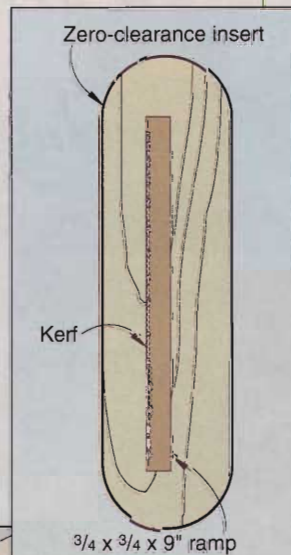

Continued on page 30

NO MORE DUST



Introducing Microplane® Rotary Shaper Power Tool Attachments for low-speed shaping. The razor-sharp teeth create tiny shavings that fall to the surface instead of clouding your air. Call 501-968-5455 or

1-800-555-2767

* dealer inquiries encouraged

www.microplane.com

email: info@microplane.com

Microplane
A Product of Grace Manufacturing®

Circle No. 2145



**ET100™
Nail Master™**

- Ergonomic Design
- Durable
- Powerful

10 Amps

**Removable
Non-Marring
Bumper**

Heavy Duty Electric Brad Nail Gun



**Shoots 3
Different
Length Brads**

5/8"
(15mm)
3/4"
(20mm)
1"
(25mm)



ARROW
Wherever fine tools are sold.

Arrow Fastener Co., Inc., 271 Mayhill Street, Saddle Brook, New Jersey 07663
Canada: Jardel Distributors, Inc., 6505 Metropolitan Blvd., East, Montreal, Quebec H1P 1X9
United Kingdom: Arrow Fastener (U.K.) Ltd., 14 Barclay Road, Croydon, Surrey CR0 1JN
www.arrowfastener.com

©2000 ARROW FASTENER COMPANY, INC. Rev. 7001

tips from your shop and ours

Masking tape "clamps" glued fragile parts

Whether by accident or design, sometimes you need to join parts too delicate for clamping. You can't repair a thin scrollsawn piece with an ordinary clamp—it would crush your work. The same is true with a frame of delicate molding. When I'm faced with these tricky tasks, I "clamp" the joint with a piece of masking tape on my bench, sticky side up. I adhere the pieces together and press the joint to the tape. Once the adhesive sets, I simply peel off the tape.

—Chuck Hedlund,

WGOD® magazine shop manager

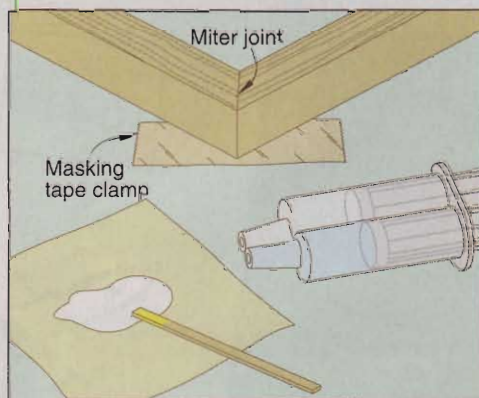

Dust collector blast gates have him seeing yellow

I painted a yellow stripe on each of the blast gates on my dust-collection system, where shown below, so that it only shows when the gate is open. Now, with a glance around the shop, I can quickly tell which gates are open or closed before opening another.

—Bob Sievert, Sonita, Calif.

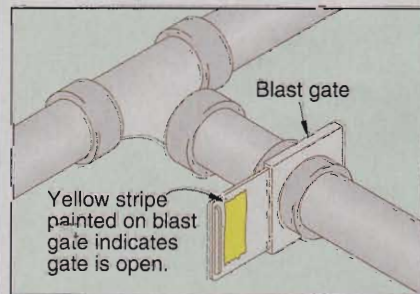

Cut this tenon-dado joint with your radial-arm saw

Tenon-dado corner joints have been around for a long time, but my method eliminates much of the fussy set-up time that's usually required. The key to this system is cutting a tenon whose thickness and width exactly matches the kerf of your saw blade.

First, cut a test dado in a piece of scrapwood. Make this kerf at least as deep as the blade's width, but its exact depth isn't important for now. Next, clamp a scrapwood stopblock to your saw's fence, and pull the running blade through the stopblock. This step exactly positions the end of the stopblock at the right edge of the blade.

Now place a scrapwood workpiece against the fence and stopblock, as shown *top right*, and cut a test tenon.

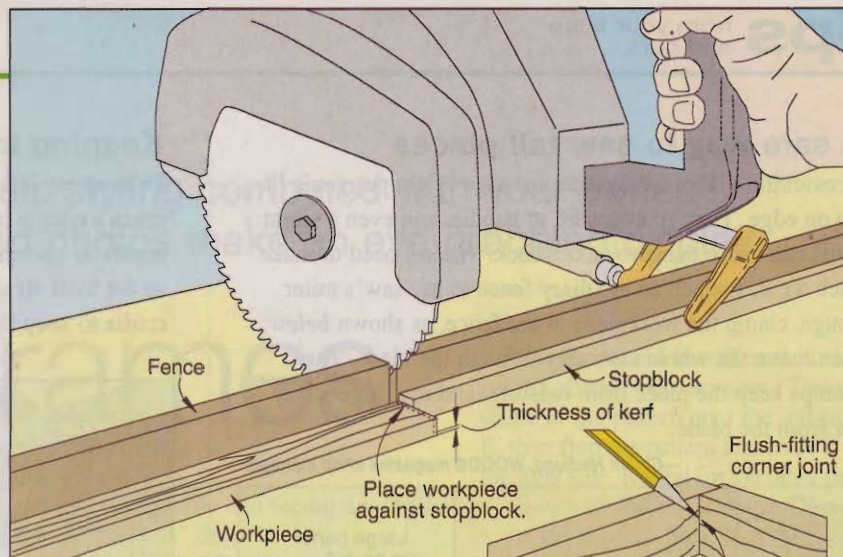

Crank the blade up or down until the tenon fits your test dado. After you've cut all the tenons, refer to the detail drawings, at *right*, to see how you'll mark for flush-fitting corner joints. Reposition the stopblock, and make test cuts to zero in on the dado's depth.

—Dr. H. M. Smith, Napanee, Ont.

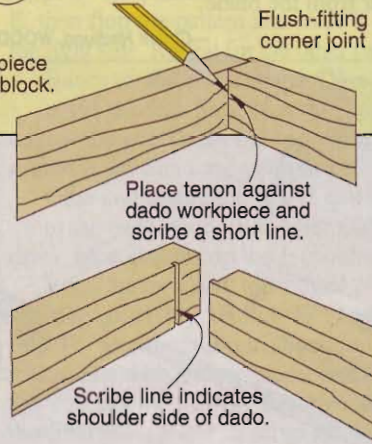

Continued on page 32



Laguna Tools Band Saw Now Only \$1,095*

No more excuses, you will never have a better time to purchase a Laguna Tools LT16 band saw. Due to the high volume of band saws that we sell, we can now give you the best band-saw value in the market. Manufactured in Italy exclusively for Laguna Tools, this powerful, swift piece of Italian ingenuity has high-quality, performance and your name written all over it.

Don't wait. Call today to get your free demonstration video.

- 12" resaw capability
- Easy blade change with 1/16 to 1" blade capacity
- 1.5 HP motor
- All-welded steel frame construction
- Cast-iron flywheels with snap on rubber tires
- Electrodynamically balanced
- Large 16" x 19" cast iron table
- Cast-iron rip fence
- 3/8" x 3/4" miter gage slot
- Two dust ports for excellent dust collection
- Blade tension indicator
- Table tilt from -10 to 45 degrees. Steel trunions
- Bearing Euro guides, both upper and lower
- Mobility kit, power feeder and 110-volt motor available

*Excludes sales tax and freight. Limited offer, while supplies last.

LAGUNA TOOLS

You Build With Wood, We Build With Trust.

800-234-1976

Circle No. 615

E Mail: mail@lagunatools.com Web: www.lagunatools.com

17101 Murphy Avenue Irvine, CA 92614 (949) 474-1200 • FX (949) 474-0150
100 Central Avenue South Kearny, NJ 07032 (973) 491-0102 • FX (973) 491-0591

A safe way to saw tall pieces

Crosscutting large workpieces on edge might put you a little on edge. They're awkward to handle, and even a slight twist can cause dangerous kickback. When I need to make such a cut, I attach an auxiliary fence to my saw's miter gauge, clamp the workpiece to the fence, as shown *below*, then move the whole assembly through the blade. The clamps keep the piece from twisting, and my fingers stay far from the blade.

—Chuck Hedlund, WOOD® magazine shop manager

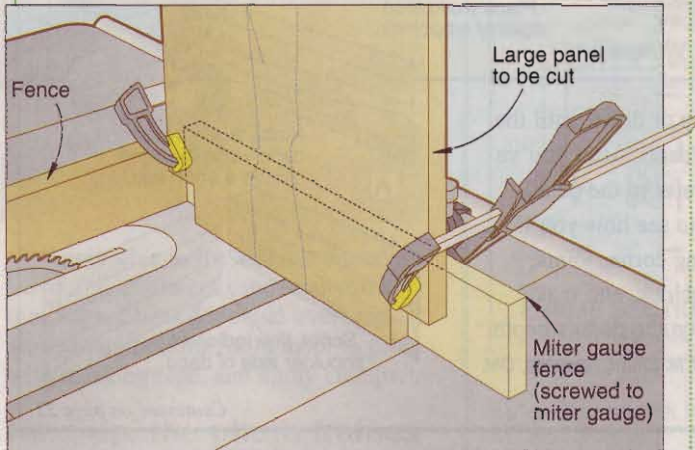

V-belt quiets noisy rocker

The sound of hardwood rolling over another hard surface such as ceramic tile is enough to put you off your rocker. So, when I built a rocking horse, I tamed the wild beast with an automotive V-belt.

Using a plunge router, I cut a dovetail groove along the bottom of each of the wooden runners, then pushed a length of the belt into each groove. The belts stay in place without glue and won't slip sideways like felt tape can.

—Kurt Heinze,
Scarborough, Ont.

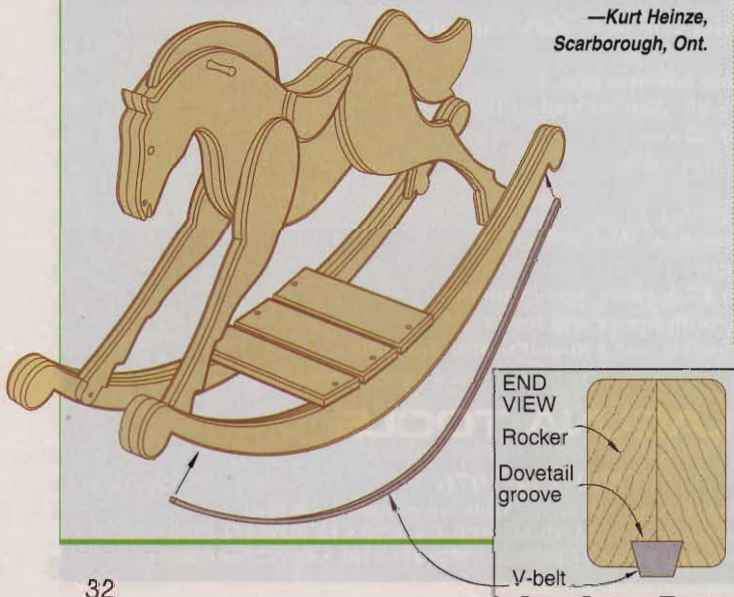

Keeping lathe tools close at hand

To keep my lathe chisels organized and within easy reach, I made a couple of cradles and screwed them to my lathe bench, as shown *below*. One cradle is lower than the other so the tools sit at an angle. The ferrules rest against the rear cradle to keep the tools from sliding.

—Chris Lopes, Louisville, Ky.

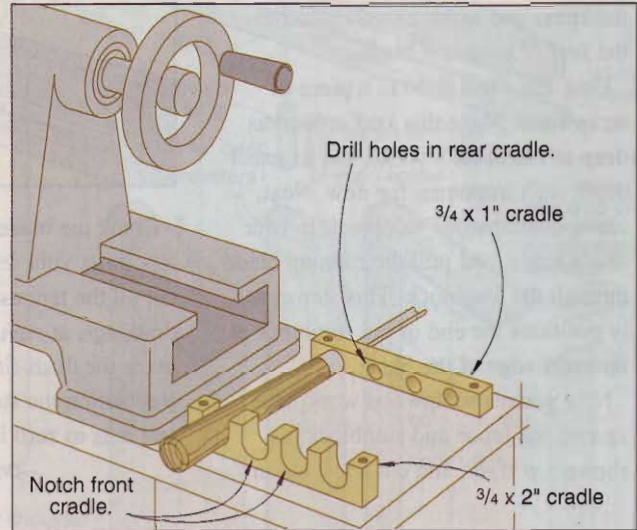

Mouse pad protects carbide cutters

Carbide tooling is a hard, long-lasting material, but it's also brittle. The carbide tips on a router bit or saw blade can be damaged easily if not carefully handled. To protect them, I keep an old computer mouse pad upside down on my bench. The spongy surface keeps the cutting surfaces safe and retards rollaway router bits.

—Chuck Hedlund, WOOD magazine shop manager

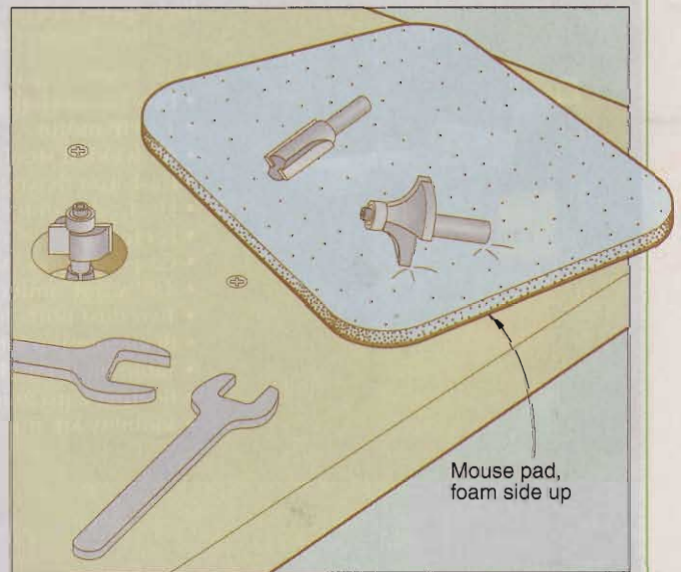

Continued on page 34

Rubber discs keep knobs from bouncing away

After changing bandsaw blades, it seemed like I always had to hunt through a pile of sawdust to find the knobs to secure the cover. To solve the problem, I cut a 1" rubber disc for each knob from an old bicycle inner tube. I punched a hole in the center of each disc, pushed the threaded end of the knob through the bandsaw cover, and stretched the disc over the threads. Now, when I change blades, the knobs stay with the cover.

— Dave Goldthorp, Dunrobin, Ont.

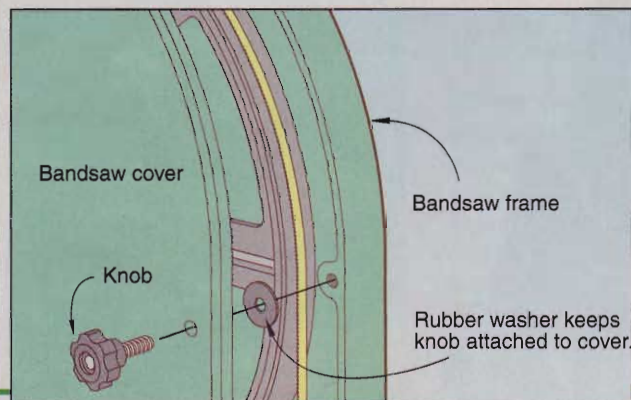

Tall turner takes his work to a new level

Because I'm taller than the average guy, some stationary tools are uncomfortable for me to work at. I spent a lot of time stooping at the lathe until I found a way to make it less of a pain.

I unbolted the lathe from its floor stand and built an open-front box to fit between the lathe and the stand, as shown below. Holes drilled through the box match the mounting holes in the tool and stand. I simply used longer bolts to fasten the three parts together. Besides adding about 4" to the tool's height, I gained a handy storage area for my lathe tools.

— John Hetherington, Des Moines, Iowa

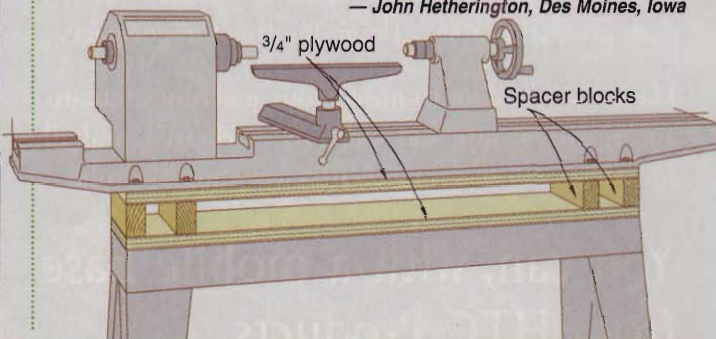

INCRA DOES IT AGAIN!



OUR ACCURACY GUARANTEE:

Produce perfect gap-free hairline glue joints on the mitered corners of any multi-sided object without trial-and-error setups.

1-800-752-0725

Woodpeckers Inc.

The Incra Tool Source

www.woodpeck.com

Incra Miter 3000

- ◆ 364 Indexed Angle Stops in 1/2° Steps
- ◆ Continuous Adjustability
- ◆ Full +/- 90° Range
- ◆ GlideLOCK™ Adjustable Miter Bar
- ◆ 27" Incra-LOCK™ FLIP Stop Miter Fence
- ◆ INCRA FLIP Shop Stop Positioner

Introducing, the **Kreg Jig** K2000 ProPack...



Featuring...

-Simple, three-step adjustability for nearly all material dimensions.

Pocket hole joinery, think outside the frame.



Kreg Tool Company
201 Campus Drive
Huxley, IA 50124

www.kregtool.com
1-800-447-8638



The Electronics Superstore that Comes to Your Door

Crutchfield's catalog has more than 140 pages packed with the latest audio and video equipment, comparison charts and buying tips you won't find anywhere else.



There's even more online. Visit our website for in-wall speakers, infrared repeaters, wall plates and everything else you'll need for beautiful custom installation work.

All the big brands: Sony, Bose, Harman Kardon, Onkyo, JVC, Infinity, Polk Audio and more.

And, once you've found what you want, you'll find a fantastic shipping deal, free lifetime tech support, and a 30-day Total Satisfaction Guarantee. It's never been so easy to get the features and performance you want.

Call today for your **FREE** catalog
1-800-555-8302
 or visit www.crutchfield.com



The Complete Car Stereo and Home Audio/Video Catalog

Circle No. 1913

tips from your shop and ours

Pipe clamps stretch your finishing area

Whenever I need to apply finish, it seems that my shop shrinks. But during a recent project, I recruited my pipe clamps into a supporting role. By attaching the clamps to my work-

bench's legs (see *below*), I suddenly gained much-needed drying space. As an added benefit, this open-air arrangement allows for plenty of air circulation to speed drying.

—Tim Barnum, Dillingham, Alaska

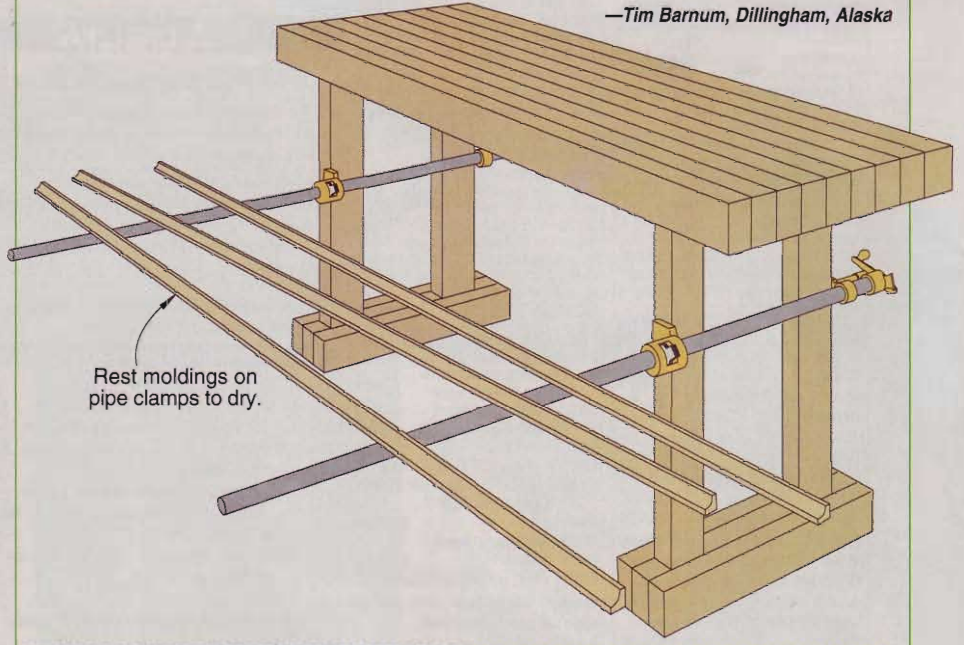

In a dangerous situation, call for backup

To make chamfer cuts safely on my tablesaw, I clamp a scrapwood backer board to the workpiece, as shown *below*. This method increases the surface area bearing on the saw's table,

making the cut easier to control. The clamps also give me a handle on the workpiece that's far from the blade. Another safety tip: use the minimum blade projection possible.

—L. N. Benfield, Rochester, Wash.

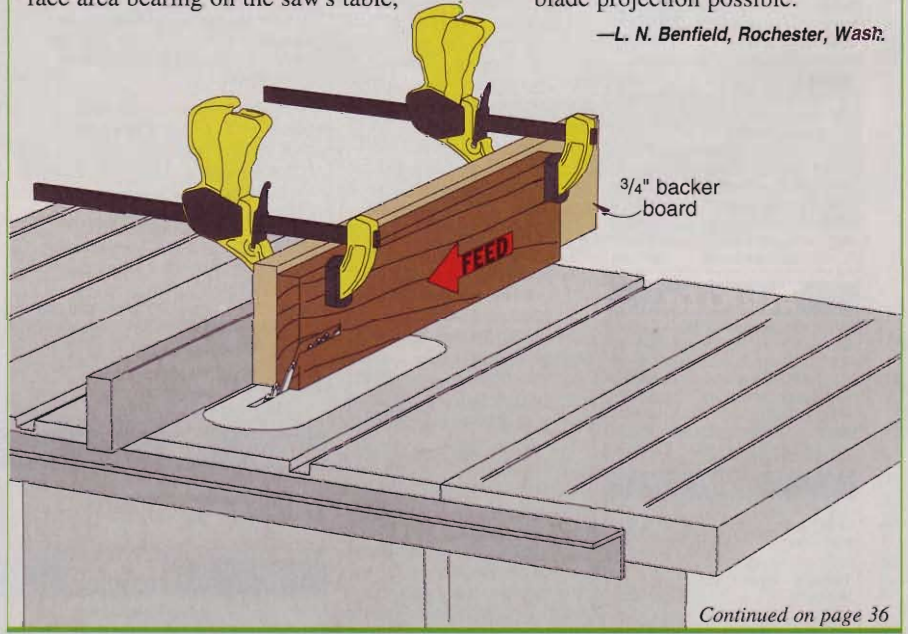

Continued on page 36

Stop collar remembers hold-down's position

I do a lot of fretwork, and every time I threaded the scrollsaw blade into a new hole, I had to reset the hold-down. The problem was adjusting the hold-down tension so the work didn't jump, but still slid smoothly. My solution was to place a drill-bit stop collar over the shaft of the hold-down assembly. When I have the hold-down tension set just right, I slide the stop collar down so it rests on the arm. Then I tighten it. The stop collar allows me to reset the hold-down in just the right position after each blade threading.

—Wolfram Sommer, Denver

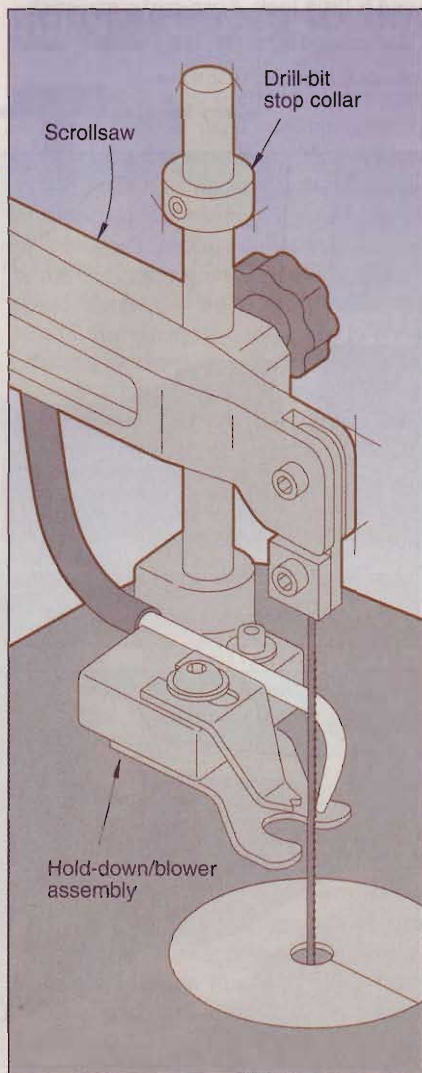

Continued on page 38

NEW INCRA Miter3000 Miter Gauge with 27" Flip-Stop Fence



GlideLOCK™ Miter Bar • AngleLOCK™ Indexing System

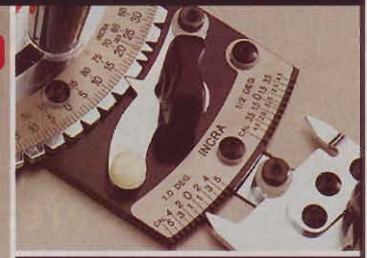

Woodpeckers Inc.
The Incra Tool Source
1-800-752-0725
www.woodpeck.com

ZAR ULTRA Interior Polyurethane A Beautiful Finish in 1/2 the Time



**Great for Floors,
Dries in 2 Hours!**

If waiting for a finish to dry just won't fly – we have just the right product for you – ZAR® ULTRA Oil-Based Interior Polyurethane. ZAR ULTRA provides a beautiful, smooth finish in just 2 hours. It is extremely durable making it ideal for high usage areas, such as floors, cabinets, furniture and doors.



ZAR ULTRA, the fastest way to a beautiful finish!

For a free brochure and dealer nearest you, call **1-800-272-3235** or visit www.ugl.com

Quality Pen Kits and Other Turning Kits



- Designers & Manufacturers
- Wholesale & Retail

THE BereaHardWoods CO. Inc.

Manufacturer of quality writing instruments, components and kits.

CALL FOR FREE CATALOG

6367 Eastland Rd. • Brookpark, Ohio 44142 U.S.A.
Ph: 440-234-7949 • Fax: 440-234-7958 • bereahard@aol.com

Circle No. 510

Refinish Your Future.



Own your own business.

Let your passion for furniture lead you into a new business with a Furniture Medic franchise. We're a complete on-site repair and restoration-refinishing business servicing homes and companies as well as handling moving and insurance claims. We offer extensive training and support with a low initial investment and manageable overhead. Financing is available to qualified candidates and franchises are offered nationwide. Call today to brush up on the details.



FURNITURE MEDIC
"the prescription for damaged furniture"

www.furnituremedicfranchise.com



1-800-RUN YOURS

Circle No. 1520

tips from your shop and ours

Finger-saving nail gripper

Installing metal shelf standards used to be rough on my fingers and my patience. The small nails were too short to safely hold with my fingers, and needle-nose pliers were awkward at best. So I came up with an easy and inexpensive gripper stick.

First, I tapered one end of a 1/8x3/4x6" strip of scrapwood. Then, I sawed a notch slightly narrower than the diameter of the nails in the tapered end. To use the stick, I dump a few nails out on my work surface and push the notch over the shank of a nail, then position it in the standard and safely hammer it home. With some careful hammering, and a little luck, I can make one stick last about 100 nails, but I usually make several at once, just in case!

—Jerry Vance, Lubbock, Texas

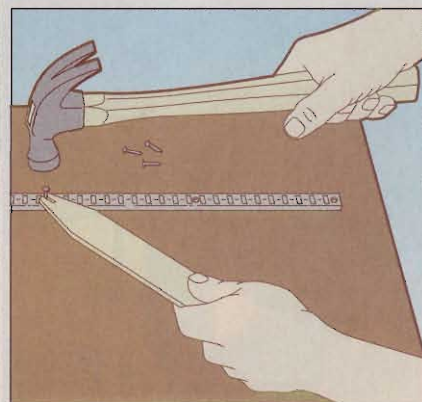
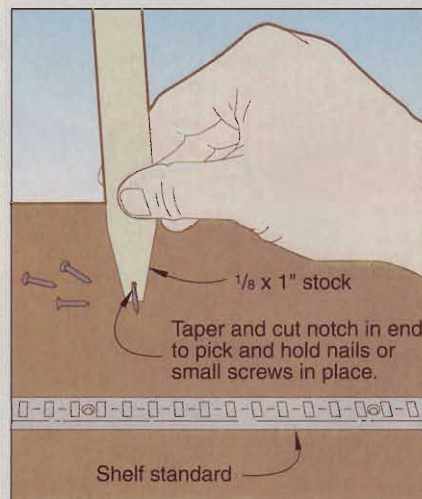

Convert open shelving into cabinets in a snap

I wanted wall-mounted cabinets in my shop, but figured that I'd have to settle for open shelving on metal zig-zag brackets. But then I realized that adding ends and sliding doors would convert my open shelves into cabinets. The door channel is inexpensive F-channel designed for installing vinyl fascia. (Look in the vinyl siding department at your local home center or lumberyard).

—Hans Claesen, Cheyenne, Wyo.,
via WOOD ONLINE®

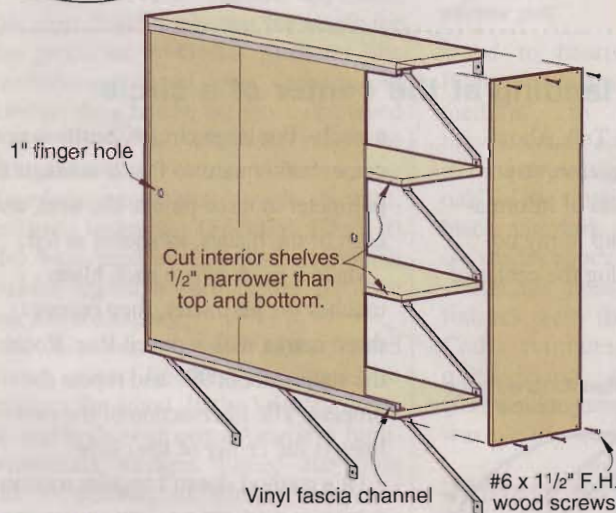
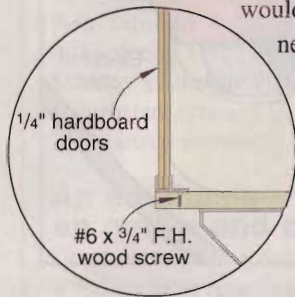

Using a holesaw just got a whole lot easier

For me, using a hole saw used to be a love/hate relationship: I loved the tool's speed in creating cutouts, but hated the time-consuming frustration of removing the plug from the saw. But then I discovered a quick trick that makes plug removal easy.

Before using the holesaw, I drill a 1/2" access hole in the waste area. Then, after I use the holesaw, I put a bolt head or hook into the access hole to yank out the plug.

—Glenn Willis, Jr., Redondo Beach, Calif.

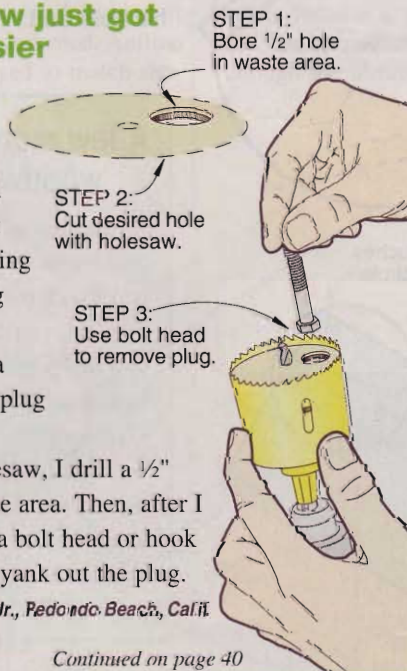

Continued on page 40

STEEBAR CORP.

(P.O. Box 980, Andover, NJ 07821-0980)

THE BEST KEPT SECRET IN THE WOODWORKING TRADE!!!

We have the largest selection of clocks,
plans, scroll saw projects, exotic lumber,
specialty items & more...

100 PAGE CATALOG – OVER 2500
ITEMS – MORE THAN 500 CLOCKS
AND WOODWORKING PROJECTS NOT
AVAILABLE ELSEWHERE

MENTION THIS SPECIAL CODE TO
RECEIVE A FREE CLOCK PLAN WITH
YOUR CATALOG REQUEST
(CODE #WOOD)

WWW.STEEBAR.COM
(973) 383-1026

TENRYU PRO SERIES

"The cuts were so quiet and effortless it felt like I forgot to raise the blade"

Hal Taylor, Museum Quality Works of Art, Hartwood, VA

Hal's comment is typical of the many we receive from craftsmen who have tried our Pro Series blades.

Each blade features:

- Expertly-tensioned, fully-hardened tool steel plates for true run
- Fine grit honing of carbide edge for clean, smooth, and easy cuts

- Resin bond-filled expansion slots for extremely quiet cuts
- High-grade, wear-resistant carbide tips for long life

Tenryu Pro Series blades are also available for cutting plastic and non-ferrous metals. So save your ears and make life easier with Tenryu blades. Ask for them at your favorite dealer or call 800-951-SAWS.

FOR YOUR SAFETY:
Follow machine and manual safety instructions.



TENRYU AMERICA, INC.
4301 Woodland Park Dr.
Suite 104
W. Melbourne, FL 32904
321-951-2400
800-951-SAWS
Fax: (321) 951-2250
www.tenryu.com

Making quality saw blades since 1910

TENRYU

IMPORTANT SAFETY NOTICE

Craftsman® Radial Arm Saws
Model Nos. beginning with 113

Emerson Tool Company has announced the voluntary recall of certain 8, 8-1/4, 9 and 10 inch Craftsman radial arm saws manufactured from 1958 through 1992 (the 8-1/4 inch through 1995) in order to provide a retrofit guarding kit. If the saw is not retrofitable, Emerson Tool will pay \$100 for the return of the carriage/motor assembly. The saws were sold without a guard that covered the entire blade. Consumers have come into contact with the blade resulting in severe injuries.

Consumers should call Emerson Tool at 1-800-511-2628 or visit www.radialarmsawrecall.com to determine if their saw is subject to the recall and to ensure that they have proper safety and use instructions.

Location of radial arm saw's model and serial number nameplate

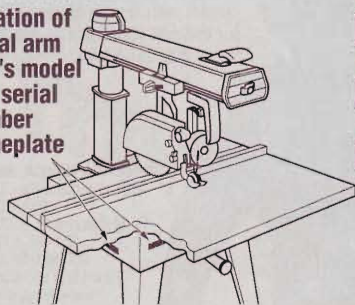

IMPORTANT SAFETY NOTICE

tips from your shop and ours

Pipe sections banish stumbling-vac woes

Cleaning the shop is a necessary evil, and a shop vacuum that stumbles over its own cord can make it a devilishly difficult task. But instead of praying for a solution, simply surround each caster with a short piece of PVC pipe, as shown in the drawing at right. The casters still roll and swivel easily, and the PVC collar shoves aside the power cord to prevent tipping.

—Ralph Tedeschi, Cincinnati, Ohio

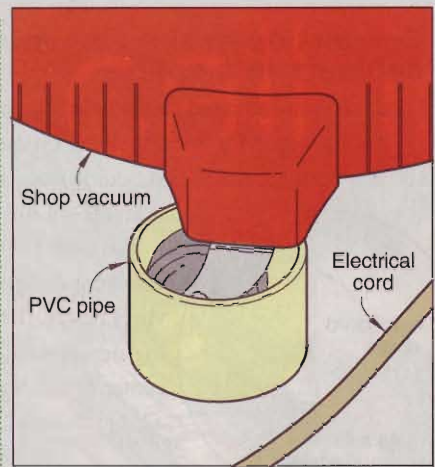

A three-point landing at the center of a circle

Your article "Straight Talk About Circles" (*WOOD* magazine, issue 124) contained a wealth of information, but I'd like to chip in my no-math method for finding the center of

a circle. For large circles, position your carpenter's square so that it contacts the perimeter at three points: the heel, and each of the blades, as shown at left.

Make a mark where each blade touches the perimeter, then connect those marks with a pencil line. Rotate the square about 90° and repeat the process. The intersection of the two lines is the center of the circle.

This method doesn't require measurements, so you can use any square corner. For small circles, I've even used a business card.

—Tom Woods, Newark, Del.

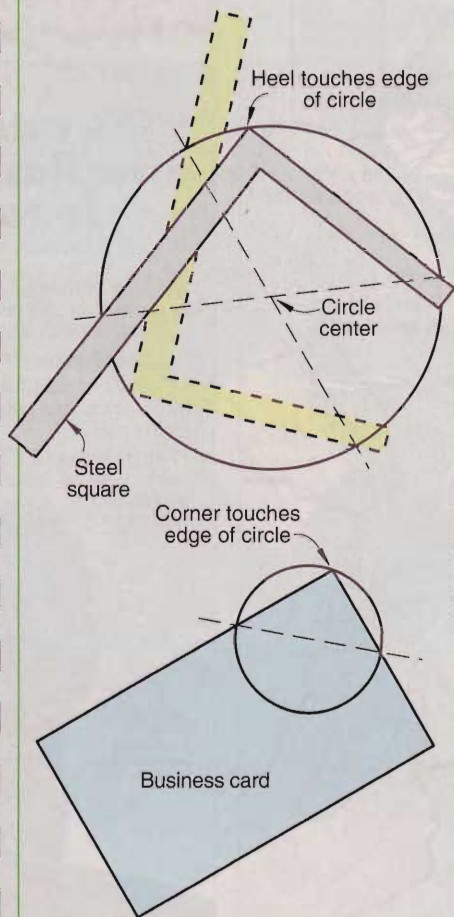

A few more tips from our woodworking pros

- Frustrated by trying to match the face frame of a built-in cabinet to a wavy wall (or more woodwork)? On page 65, you'll learn a simple way to transfer that wall contour directly to your workpiece.
- To ensure matching grooves, rabbet, and dados in multiple small pieces, rout, then rip. See how it works in The Handcrafted Home wall sconces project, beginning on page 66.♣

what they make
**from
a tree**

Sure, there are the boards you machine in the shop. But there's also a host of other products made by modifying the wood from a log.

U.S. manufactured plywood takes root in 1905

The history of the veneer used in plywood production, though, goes back much further. Egyptian craftsmen in 1500 B.C. applied thin slices of costly, hard-to-get woods to more common woods in the making of royal furniture.

Plywood employs thin sheets of veneer glued and pressed together with the grain running in alternate directions. The alternate grain direction provides great stability, as well as strength.

Softwood veneers, from trees such as Douglas fir and southern pine, are produced by peeling a log on a lathe as you would take the skin off an apple, and are called rotary-cut. Rotary-cut plies go into structural plywood.

Hardwood veneers from trees like oak and walnut are made by slicing a squared log down its length. These veneers then are glued to the top and back faces of the decorative plywood used in furniture and cabinets. The inner plies may be softwood veneer or veneer cut from hardwood species, quite often gum and poplar, or even solid wood.

Laminated-veneer lumber cuts just like sawn stock

Developed in the 1940s, laminated veneer lumber was targeted for the pro-

Rotary Cutting

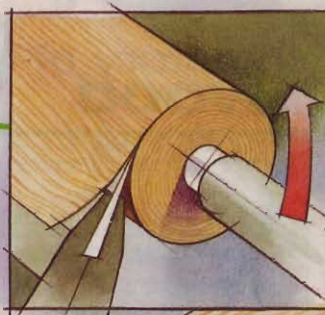

Plywood

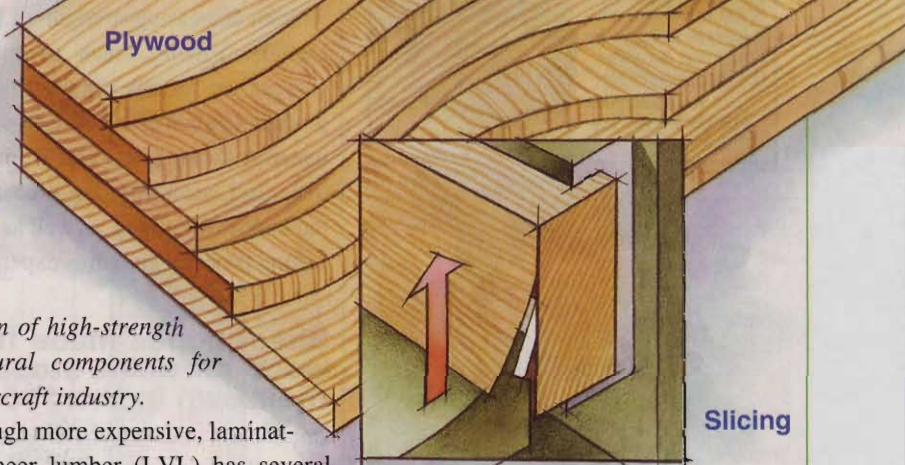

Slicing

Glued-laminated timbers first saw use in 1893 for arches in Switzerland

If you glued up a stack of sawn boards with the grain of all layers running parallel, you'd have a glulam timber.

The lumber employed for glulam varies according to species and size, but does not normally exceed 2" in thickness. And the layers typically are laid up horizontally but also may be vertically glued for arched structural elements, such as supports for a domed roof. Finger-joining the members in the glue-up makes extremely long lengths possible (500' spans have been recorded).

Continued on page 44

duction of high-strength structural components for the aircraft industry.

Although more expensive, laminated veneer lumber (LVL) has several advantages over sawn lumber. For some applications, such as long scaffold planks, window and garage-door headers, and I-beam flanges, LVL's straightness, high strength-to-weight ratio, and extra length can't be attained with standard dimensional lumber. It's also used for curved arches. Because LVL is produced with dry veneer (usually in 1/10-1/8" thickness) in multiple layers with the grain all running in the same direction, it less likely to warp.

At present, LVL can be produced in widths up to 50" and thicknesses equivalent to dimensional lumber. Long lengths are achieved by end-joining LVL billets with scarfs or overlaps.



The laminated wood arches in the building, far left, have lines that please the eye. The laminations were bent and glued in large forms. Left, a massive glulam beam features glued-up boards with their grain direction all running the same way. Many species of wood may be used.

bill of materials

Note: All boards are cut and planed from one 3/4 x 4 1/4 x 96" piece of white oak.

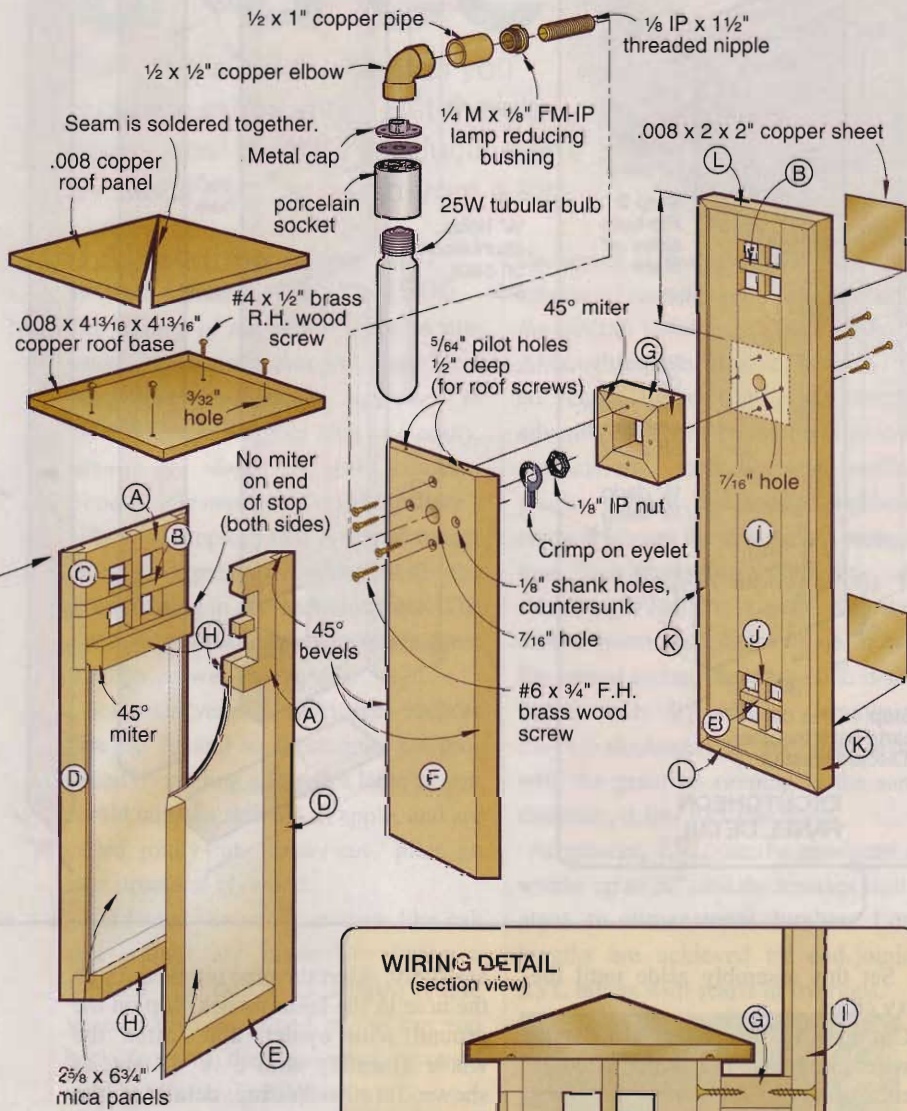
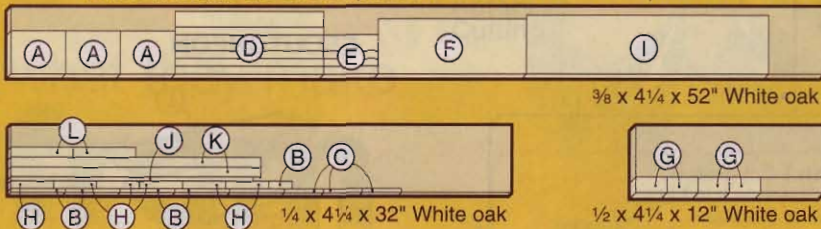

EXPLODED VIEW

WIRING DETAIL
(section view)

bill of materials

wall sconces

| Part | FINISHED SIZE | | | Matl. | Qty. |
|-----------------------|---------------|--------|---------|-------|------|
| | T | W | L | | |
| A* lantern panels | 3/8" | 2 3/4" | 3 1/2" | O | 3 |
| B horizontal mullions | 1/4" | 1/4" | 3 1/2" | O | 5 |
| C vertical mullions | 1/4" | 1/4" | 2 1/2" | O | 3 |
| D** stiles | 3/8" | 1/2" | 9 1/2" | O | 6 |
| E** rails | 3/8" | 1/2" | 3 1/2" | O | 3 |
| F lantern back | 3/8" | 3 1/2" | 9 1/2" | O | 1 |
| G ring segments | 1/2" | 1" | 2" | O | 4 |
| H** stops | 1/4" | 1/2" | 2 3/4" | O | 6 |
| I* escutcheon panel | 3/8" | 3 3/4" | 15 1/2" | O | 1 |
| J escutcheon mullion | 1/4" | 1/4" | 15 1/2" | O | 1 |
| K** side banding | 1/4" | 5/8" | 16" | O | 2 |
| L** end banding | 1/4" | 5/8" | 4" | O | 2 |

*Initial size shown. Parts are smaller after machining.
** Parts initially cut oversize.

Material Key: O-oak

Supplies: #6x3/4" flathead brass wood screws (8), #4x1/2" roundhead brass wood screws (4), 25-watt frosted tubular lightbulb.

Buying Guide

Hardware kit for one sconce: .030 sheet mica, .008 copper sheet, 1/2x1" copper pipe, 1/2" copper elbow, 1/4x1/8" IP lamp reducing bushing, 1/8x1 1/2" IP lamp nipple, 1/8" IP lamp nut, porcelain lampholder, crimp-on eyelet, J-B Weld metal-filled epoxy, #18 fixture wire (10" each: black, white, green). Order kit #WS, \$31.50 ppd. for one sconce, \$59.95 for two. Schlaubaugh and Sons Woodworking, 720 14th Street, Kalona, IA 52247, or call 800/346-9663.

4 Rip a 1/2x18" strip from the 1/4" stock for the mica stop (H). Cut a 1/8" rabbet the thickness of the mica panel on one edge, and cut the stops to length. Miter both ends of the front stops, and one end of the side stops, as shown on the Exploded View drawing. Glue and clamp the top three stops in place. Set the others aside.

Craft a matching escutcheon

1 From the 3/8" stock, cut the escutcheon panel (I) to the size listed. Now, in a process similar to that used to form the lantern side and front panels, follow the four steps shown in the Escutcheon Panel detail on the Escutcheon drawing to form this part. When glued back together, the panel has two dados and a groove to accept mullions (B, J) and a 1 1/2x1 1/2" cutout at each end.



family room renovation

Add style and value to your living spaces with a woodworking facelift



Welcome to the kickoff of "The Handcrafted Home." In this series of articles, we'll seek to inspire and inform you about ways to use your woodworking skills and tools to add lasting value and beauty to your home.

For this first installment, we converted the dated family room *below* into a

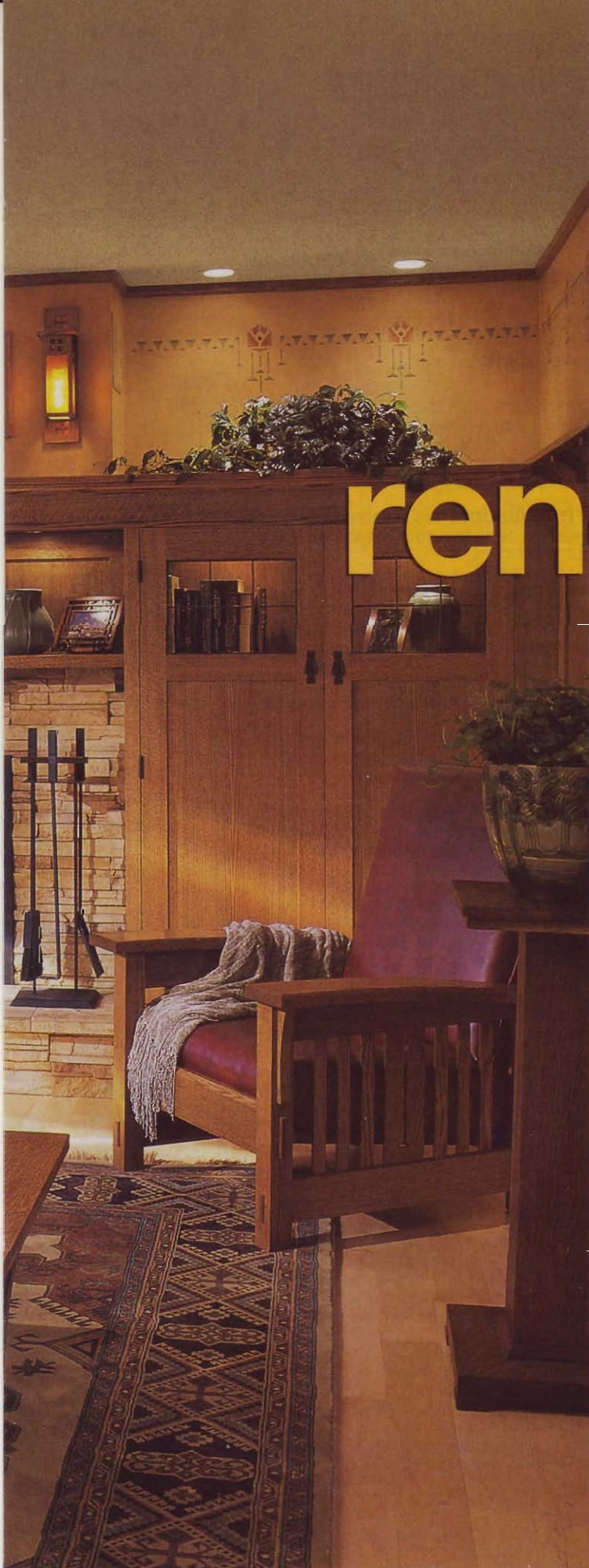

The original space, complete with sheet paneling and shag carpeting, retained its distinctly '60s look.

family room renovation

space any woodworker would be proud to create. On the following pages you'll discover how to build and install all of the woodwork that surrounds the fireplace and lines the walls.

Although our room has a distinctive Arts-and-Crafts flair because of design elements, such as the wall stenciling, framed pictures, stained glass, and furnishings, the design of the built-in woodwork complements most traditional interiors. You may want to change the stain color, wood species (we used quartersawn solid oak and riftsawn oak plywood throughout), or hardware to suit your interior. For example, the same woodwork in walnut would lend a

If the Mission furniture grabs your eye...



All of the wooden furnishings shown in the photo on the previous pages, except for the plant stand (we found that at an antiques-store) are available for purchase. You can obtain downloadable plans of the Sofa/chair (one plan), coffee table, nesting tables, mantel clock, or Morris reclining chair at: woodstore.woodmall.com/misfur.html Or, send \$5 per project article reprint to WOOD magazine reprints, 1716 Locust St., GA-310, Des Moines, IA 50309-3023.



As seen in issue 129

Transforming a family room step-by-step

Although the complete renovation of a family room may seem like a daunting task, you can achieve impressive results through a series of simple steps. Here, in order, is how this family room took shape. You'll find complete how-to instructions for the **wall-paneling**, **bookcases**, and **light sconces** in the three articles that follow this one. For do-it-yourself information on some of the non-woodworking aspects of this project, go to woodonline.com

Articles found in this issue

Information covered online

- 1 Wall preparation.** Rather than tear out the dated sheet paneling, we covered it with a heavy wall covering (Heavy Duty Wall Liner by Village Home purchased at Home Depot) that provides a joint- and groove-free surface. Go to www.woodmagazine.com/handhome/update1.html
- 2 Oak paneling installation.** We installed shop-made paneling of solid oak and oak plywood as described in the article on [page 52](#).
- 3 Heat duct enclosure.** To hide the heat ducts, we built an enclosure of $\frac{3}{4}$ " plywood and 1x2 cleats screwed to the wall and ceiling. We extended the ducts and added elbows so heat exits the sides of the enclosure.
- 4 Wall paint.** The walls were sponge painted, then stenciled. Go to www.woodmagazine.com/handhome/update3.html
- 5 Hardwood floor.** An engineered hardwood floor was glued to the concrete slab. For more information, go to www.woodmagazine.com/handhome/update4.html
- 6 Upper mantel.** Two $1\frac{1}{2} \times 4\frac{1}{2}$ " beams laminated using $\frac{3}{4}$ " plywood support an upper mantel of $\frac{3}{4}$ " oak plywood. $1 \times 1\frac{1}{2}$ " upper mantel support posts attached to the side walls support the outer front edge of this mantel.
- 7 Built-in bookcases.** Before building and installing the bookcases, as shown on [page 60](#), we screwed bookcase support blocking to the wall and fireplace brick, then finish-nailed the baseboards to the blocking and upper-mantel support posts.
- 8 Lower mantel.** The lower mantel with brackets was fitted between the bookcases. We nailed a $\frac{3}{4}$ " oak-plywood ceiling, with recessed-light holes, to the laminated beams. A center panel that hides low-voltage transformers (see photo at *left*) was constructed of $\frac{3}{4}$ " oak and $\frac{1}{4}$ " oak plywood. $\frac{3}{4} \times 1\frac{1}{2}$ " panel stops with four magnetic catches hold the panel in place.
- 9 Fireplace.** We applied cultured stone directly against the lower brick surface with construction adhesive. A hearth of 12×12 " ceramic tiles was added. Then, we applied cultured stone to the upper vertical brick surface. Brass trim strips were riveted to the existing fireplace-insert doors, and the frames and doors were painted black. Go to www.woodmagazine.com/handhome/update6.html
- 10 Stained-glass windows.** The existing window panes were replaced with stained-glass panels. You'll find a step-by-step stained-glass seminar at www.woodmagazine.com/handhome/update7.html
- 11 Wall sconces.** To build and install these beautiful Mission-style light fixtures, see [page 66](#).



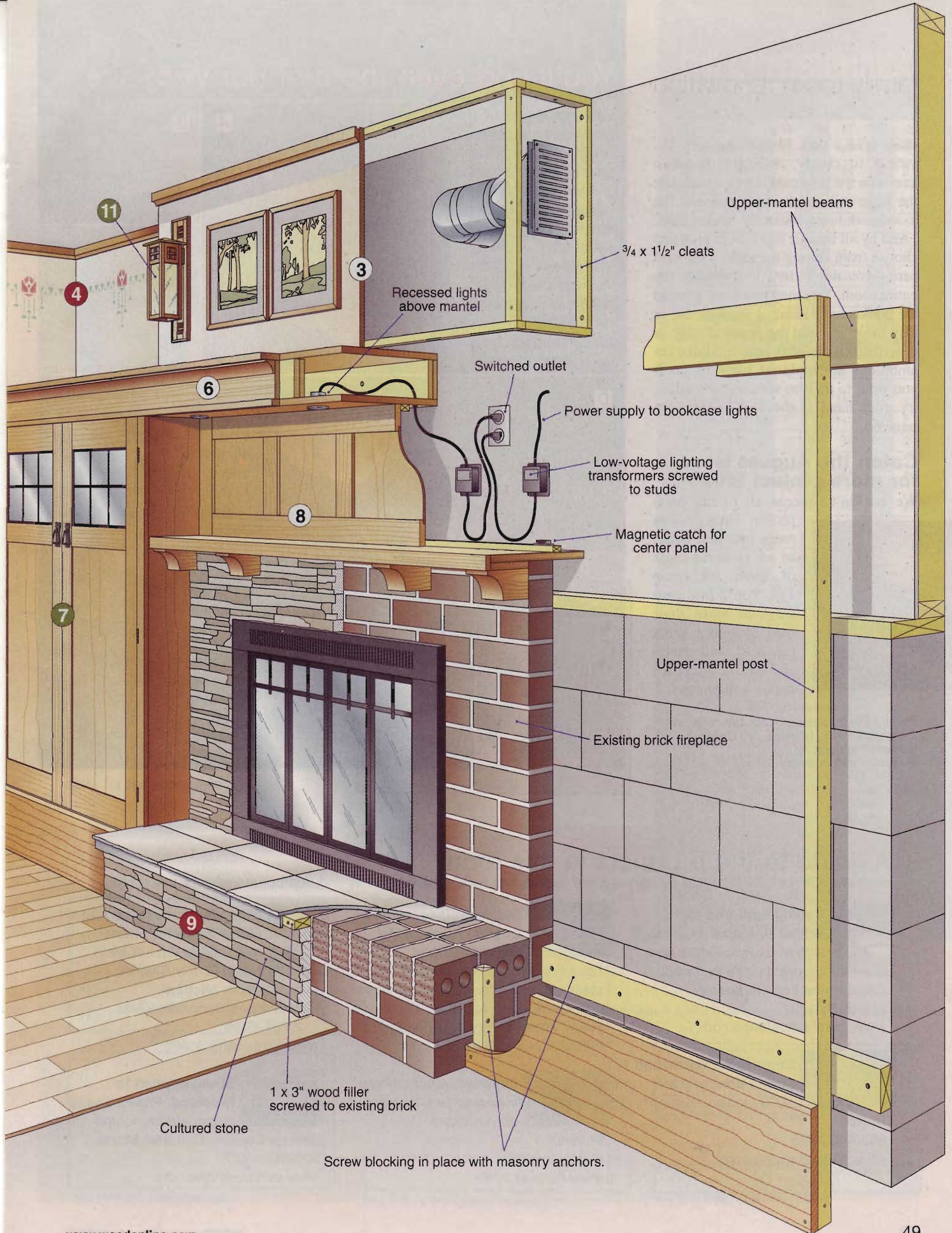

family room renovation

study area a rich, library-like feel. Or, switch to cherry, substitute wooden knobs on the bookcase doors, and delete the plate rail and its brackets, and the woodwork has a distinctly Shaker flair.

And by all means, feel free to pick and choose from among the ideas presented here—you don't need to duplicate the entire room. You may just want to build the bookcases described on *page 60*, or skip those and add the paneling only as described in the next article. Those are ambitious undertakings for sure, so if you want to take on something smaller, try your hand at the wall sconces on *page 66*.

Catch the August issue for more project ideas

We couldn't squeeze all of the great project ideas in this room into one issue, so we've saved some of them for issue 134. You'll find easy ways to make your own air-return grills (at *left*) and Arts-and-Crafts electric-outlet wall plates.



Produced by **Bill Krier** with **Jim Downing**
Photographs: **Wm. Hopkins, Jim Downing,**
Baldwin Photography
Illustration: **Kim Downing**

You'll find even more at our Web site

We know that in a room overhaul like this one, your curiosity may extend beyond woodworking. So, we've included coverage of the following skills at www.woodmagazine.com/handhome/

- Application of the cultured stone and tile on the fireplace. *Photo A.*
- How to cover up the old wall paneling with a special wallpaper for a

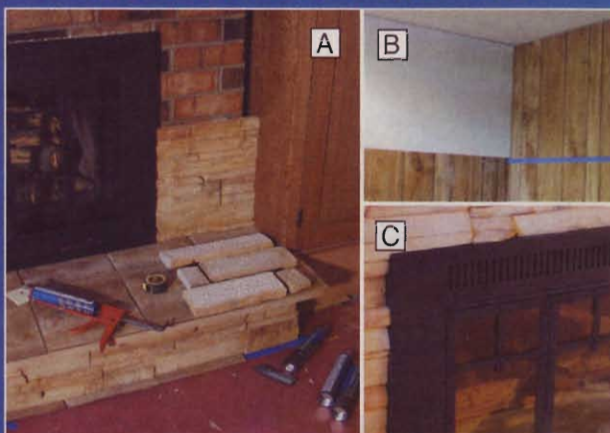

smooth, painted surface that mimics drywall.

Photo B.

- A quick way to give fireplace doors a decorative look with a few strips of brass. *Photo C.*
- Installation of the engineered hardwood floor. *Photo D.*
- How to stencil the motif along the top of the walls. *Photo E.*
- Step-by-step instruction in making stained-glass panels. *Photo F.*

Be sure to stop in—it's absolutely free.

A guide to the products in this room

Here are some of the products we hand-picked because of their quality features and appropriateness for this room:



Ceiling light and fan.
Artisan II, model no. 94032T with mica light fixture and programmable features.

Casablanca Fan Company
888/227-2178
www.casablancafanco.com



Engineered hardwood floor. *Pattern-Plus 5000, natural maple.*

Hartco
800/442-7826
www.hartcoflooring.com



Stained-glass windows.
Custom-made by Art Glass Creations.

For a full-size pattern send \$5 and a stamped, self-addressed, business-size envelope to **Art Glass Creations**, 10417 Hickman Road, Urbandale, IA 50322. Call 515/276-3026.



Stencils. *"Landscape frieze" above fireplace. "Prairie rose" along tops of walls, Helen Foster Stencils.*

Available from **Michael Fitzsimmons Decorative Arts**
312/787-0496
www.fitzdecarts.com



Finishes. *Aged oak gel stain and fast-drying polyurethane.*

Minwax
800/523-9299
www.minwax.com



Stone applied to fireplace. *Pro-Fit Ledge-stone, autumn color.*

Owens-Corning Cultured Stone
800/255-1727
www.culturedstone.com

tradition

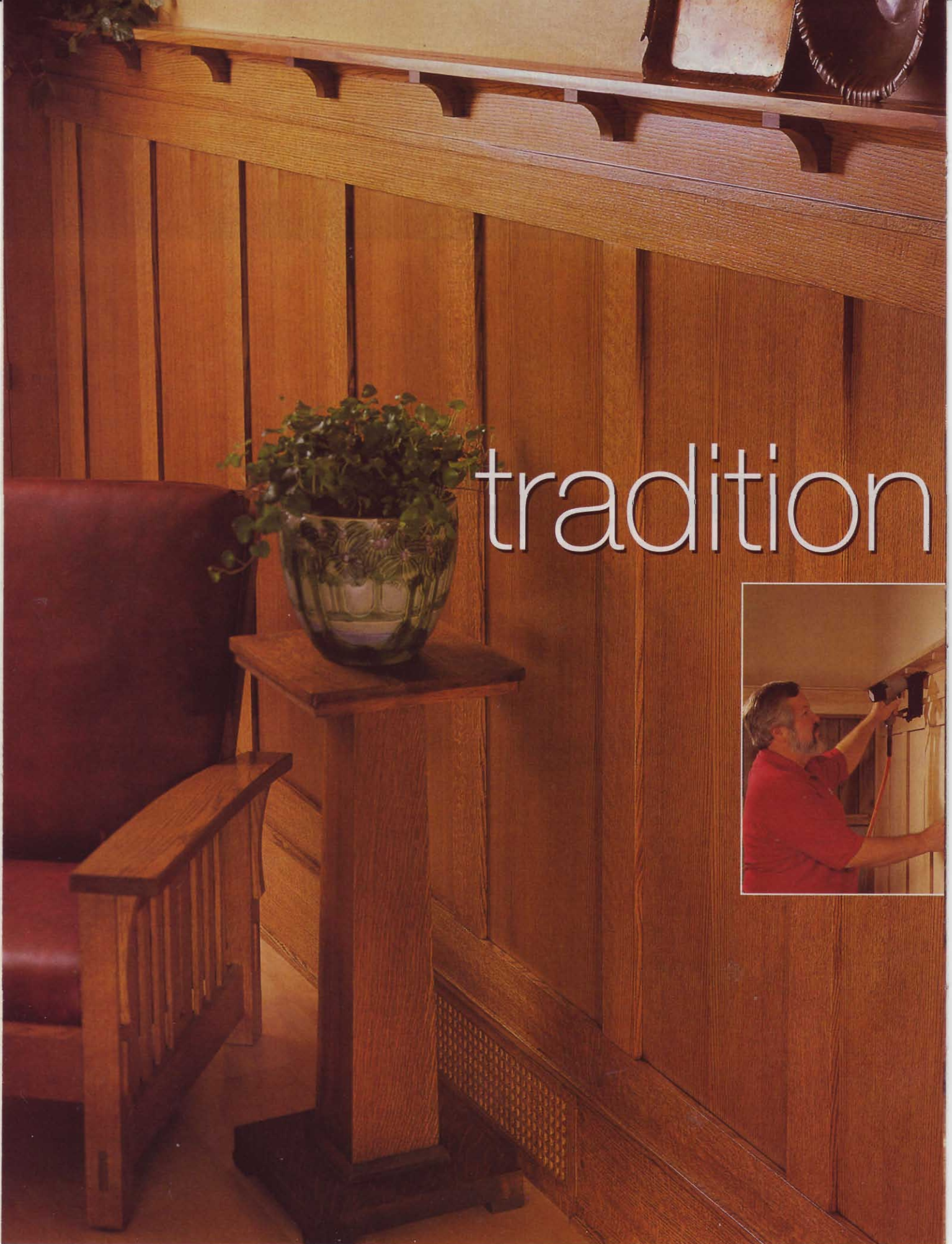

FAMILY ROOM RENOVATION

al wall paneling installing



Fine furniture and elegant accessories shine brightest in a proper setting, so

give them the rich wood surroundings they deserve

That drab, fake-wood paneling looked outdated about a month after somebody nailed it to your family room walls.

Never fear, it won't happen this time. When you wrap a room with hardwood plywood panels, separated by solid-wood mullions and topped by a handsome plate rail, you not only add quality materials, you invest in a classic, time-honored style.

As a key part of our family room makeover, *WOOD*® magazine senior design editor Jim Downing covered a tedious expanse of 1960s-style paneling in his lower-level family room with this elegant Arts and Crafts treatment, featuring quartersawn oak. You can see the finished results in the photo *opposite*, and on *page 52*.

Take time to plan

You'll find the woodworking for this project fairly straightforward. But the planning stage could pose a bit of a challenge. Will you need to add or move electrical outlets and switches? How will you handle the heat registers? If you have windows to trim around, does that dictate the mullion spacing?

You can apply the following technique in any family room or den, whether it's in the basement or upstairs. Concrete block walls will require furring strips and drywall before you start to panel.

In any case, make a scale drawing of each wall involved in your project. It will focus your attention on any potential problems and help you visualize the end result. The Wall Panel and Plate Rail Assembly drawing on *page 54* gives the dimensions we used. You might use different measurements for the panels, for example, but use the drawing to plan your construction details.

Just like cabinet doors, these panels need proper proportions to look good. To avoid waste, you could plan to cut a 4x8' sheet of 1/4" plywood lengthwise into three equal strips, each 15 7/8" wide. However, we ended up with 17" widths when we chose to center one mullion on the wall and one under each window for a nice, symmetrical look. Don't drive yourself crazy trying to find the one width that will work perfectly all around the room. If you need to make an end panel wider than the rest by an inch or so, go ahead—no one will notice the difference. As for the height,

traditional wall paneling

plan for the plate rail to perch about 6' above the floor. You might choose to vary the distance slightly to suit personal taste—or personal height.

Start shaping the pieces

Measure the thickness of your plywood before you begin shaping the rabbets on the mullions. Sometimes, 1/4" plywood is less than 1/4" thick. The panels must fit snugly in the rabbets for the project to look its best.

If your wall has windows with interior trim that won't match your new paneling, replace the trim with a flat frame of oak. We cut the trim pieces 4" wide. Rather than working on the wall, we

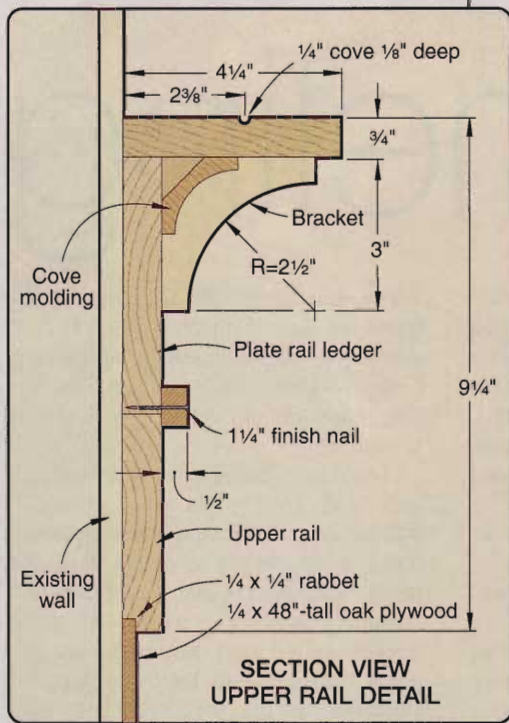

used a biscuit joiner to assemble each frame in the shop, carried it to a window, and nailed it in place. Doing it that way helps ensure square corners and tight miter joints.

We made the plate rail brackets from 8/4 lumber, or you could laminate pieces of 4/4 stock. Cut a template to match the shape shown in the Section View Upper Rail Detail drawing, above. Trace that shape onto each piece of stock, saw close to the line, and finish up with a drum sander.

A pneumatic brad nailer really speeds up a big project such as this one. When

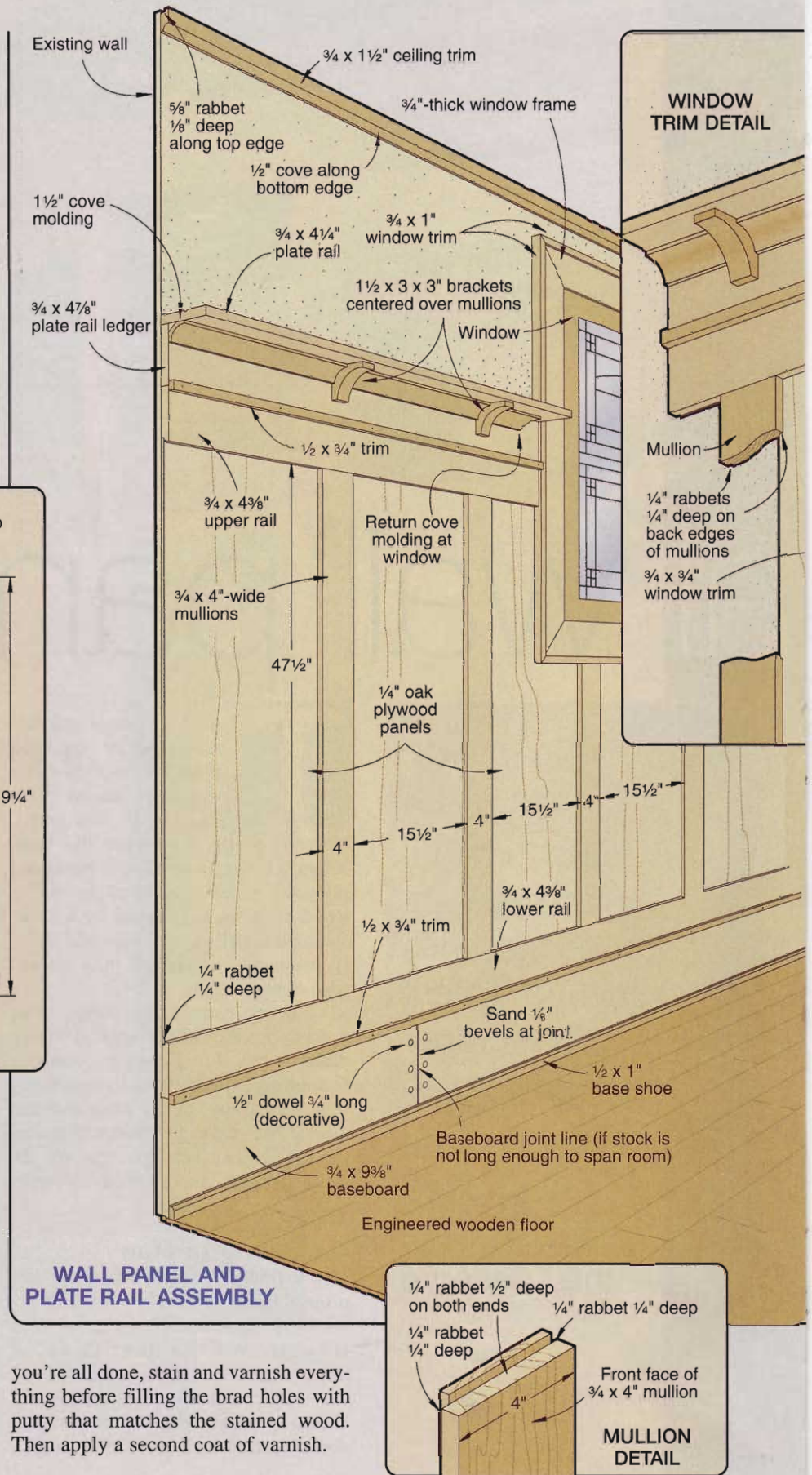

you're all done, stain and varnish everything before filling the brad holes with putty that matches the stained wood. Then apply a second coat of varnish.

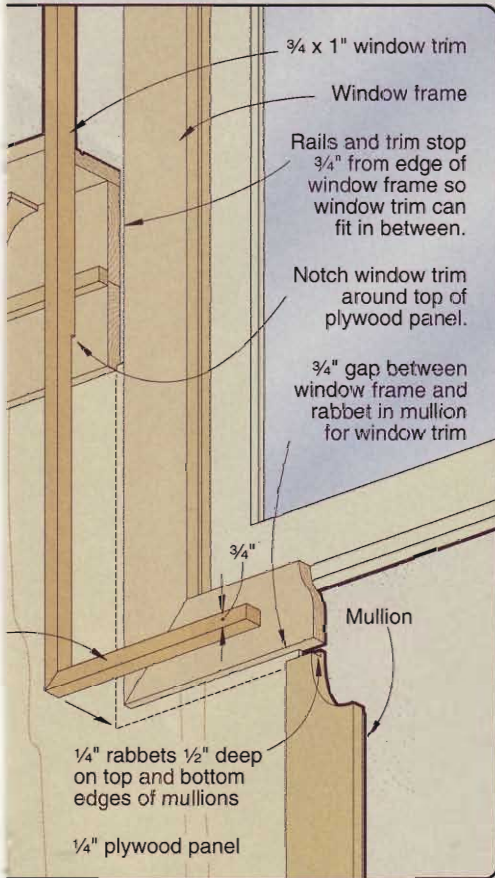

See the drawings on the *opposite page* for the dimensions of the mullions, baseboard, rails, ledger, and plate rail. In an upcoming issue, we'll show you how to make outlet covers, switch plates, and heat registers, all matching the new style of the room.

Six steps to installation

1 Base. In most situations, you can put your new panels right over the existing wall, as we did. Above the area to be paneled, we covered the old paneling with a heavy-duty wallpaper specially made for hiding imperfections.

Begin building at the bottom with a big, solid-looking baseboard. We used $\frac{3}{4}$ " boards $9\frac{3}{8}$ "-wide, cut a slight chamfer on the edge of any boards that butt together, and used a biscuit joiner to keep those joints lined up. We used a level to keep the boards straight despite an uneven floor. Slight gaps disappeared when we laid a wood floor on top of the existing concrete.

A $\frac{3}{4}$ " board $4\frac{3}{8}$ " wide sits on top of the baseboard and serves as the lower rail

for the panel frames. Nail those boards into the wall studs. Later, after our new flooring was in place, we nailed on a piece of base shoe.

2 Paneling. Temporarily set the mullions in place, as shown in *Photo A*. Mark their locations on the wall. We used a strip of masking tape at the top end so the marks would stand out. The *inset photo* shows you how to hold the mullions while you make sure everything is lined up properly. Drive a screw into the wall just above the rabbeted tongue. The screw head keeps the board in place. Then make matching alignment marks on the tape and the board. Once they're all up and the layout looks good, cut the panels to fit.

Stock up on construction adhesive, because those tubes will empty quickly from this point on. Starting at one end of a wall, fasten the first mullion into place, keeping it square with the baseboard. Apply a wavy bead of adhesive down its back and two nails through the tongue of the upper rabbet.

Apply a wide, wavy bead of adhesive to a panel, slip it into the rabbet of the baseboard, as shown in *Photo B*, then slide it into the side rabbet of the mullion and press it against the wall. When you come to the new window frame, cut panels to fit snugly against it.

Leave a $\frac{3}{4}$ " gap between the window frame and the face of each mullion, as seen in *Photo C*. This gap allows for the piece of trim that comes next.

3 Window trim. Cover the seam between window frame and wall panel with a $\frac{3}{4}$ "x1" strip. As shown in *Photo D*, you'll cut a notch on the side strips that's $\frac{1}{4}$ " deep and runs from the lower end of the trim strip to the top edge of the paneling. The strip along the bottom of the window is $\frac{3}{4}$ "x $\frac{3}{4}$ ".

Nail these trim pieces to the frame with brads. Our pneumatic nailer created some problems by sending several brads curving out through the face of the wood. If you have the same trouble, you can always switch to a hammer.

4 Upper rail and ledger. Mirroring the baseboard design, an upper rail and a plate rail ledger run across the top of the paneling. The rabbet along the bottom edge of the upper rail mates with the panels and the rabbeted end of each mullion.

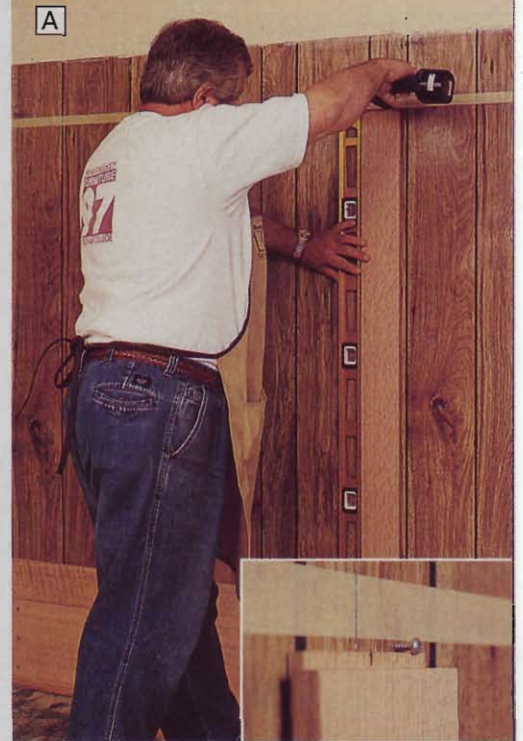

Align the mullions, as in *Photo A*, to check your layout. The inset shows how to hold them before you're ready to nail. Slide the panels into place, as in *Photo B*. Fit the window trim pieces, as in *Photos C and D*.

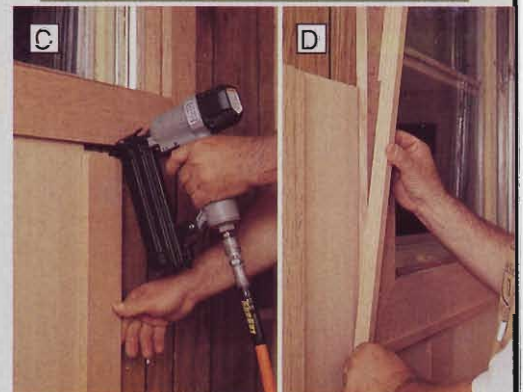

traditional wall paneling

The plate rail ledger sits atop the upper rail, as shown in *Photo E*. Fasten both of those boards to the wall studs with finish nails.

A $\frac{1}{2} \times \frac{3}{4}$ " trim strip covers the seam between the ledger and upper rail, and another strip of the same dimensions covers the seam between the baseboard and lower rail. *Photo F* shows a homemade gauge that helps you install each trim piece perfectly straight. Glue two scraps together to form a gauge that hangs on the top edge of the ledger and locates the top edge of the trim. Make another for the narrower lower rail.

5 Brackets. Drill pocket-screw holes in the top of each bracket, and center a bracket above each full-length mullion,

shop

tip

For a classy finishing touch, we went for a "pegged" look at each joint along the baseboard. Drill three $\frac{1}{2}$ " holes $\frac{3}{8}$ " deep along each side of the joint, 1" from the joint and evenly spaced across the width of the board. Cut $\frac{5}{16}$ "-long plugs from a $\frac{1}{2}$ " oak dowel, dab on a bit of yellow glue, and place them in the holes. Set each plug flush by holding a block of wood on top of it and tapping the block with a hammer. You also can use this technique for built-in cabinets and hardwood flooring, as long as it suits the style of the room.



using a square to mark the location on the ledger. Align the top surface of each bracket with the top edge of the ledger to support the plate rail shelf.

Hold a small square against the bracket to keep it lined up while you nail through the lower end. Then drive a self-tapping pocket screw through the hole, as shown in *Photo G*. If you don't have a pocket screw jig, you can toenail the bracket in place from the top.

6 Plate rail shelf. Nail the plate rail shelf to the ledger and the support brackets. The final bit of trim consists of $1\frac{1}{2}$ " oak cove molding, available at home centers. Cut pieces to fit exactly between the brackets, and nail them in place, as shown in *Photo H*.

When we came to the windows, we cut the end piece of molding to make a "return." See *Drawing 1, below*, for cutting details. Glue the return to the molding as shown. It sits 2" from the end of the shelf. ♣

Written by **Jim Pollock** with **Jim Downing**
Photographs: **Baldwin Photography**
Illustrations: **Kim Downing; Lorna Johnson**



After you fit the ledger board in place, as in *Photo E*, the simple jig shown in *Photo F* helps you keep the trim strip straight. Pocket-hole joinery, shown in *Photo G*, speeds the bracket installation. Use a brad nailer for the molding, as in *Photo H*.



DRAWING 1
Cutting the cove return piece

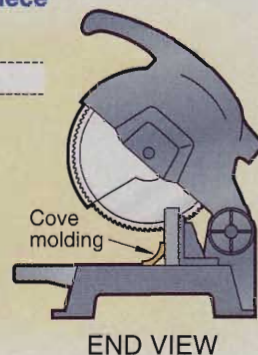
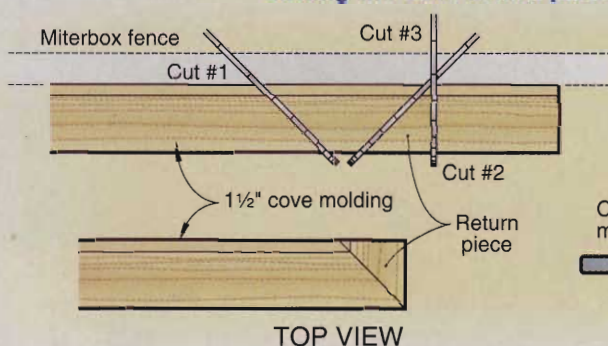

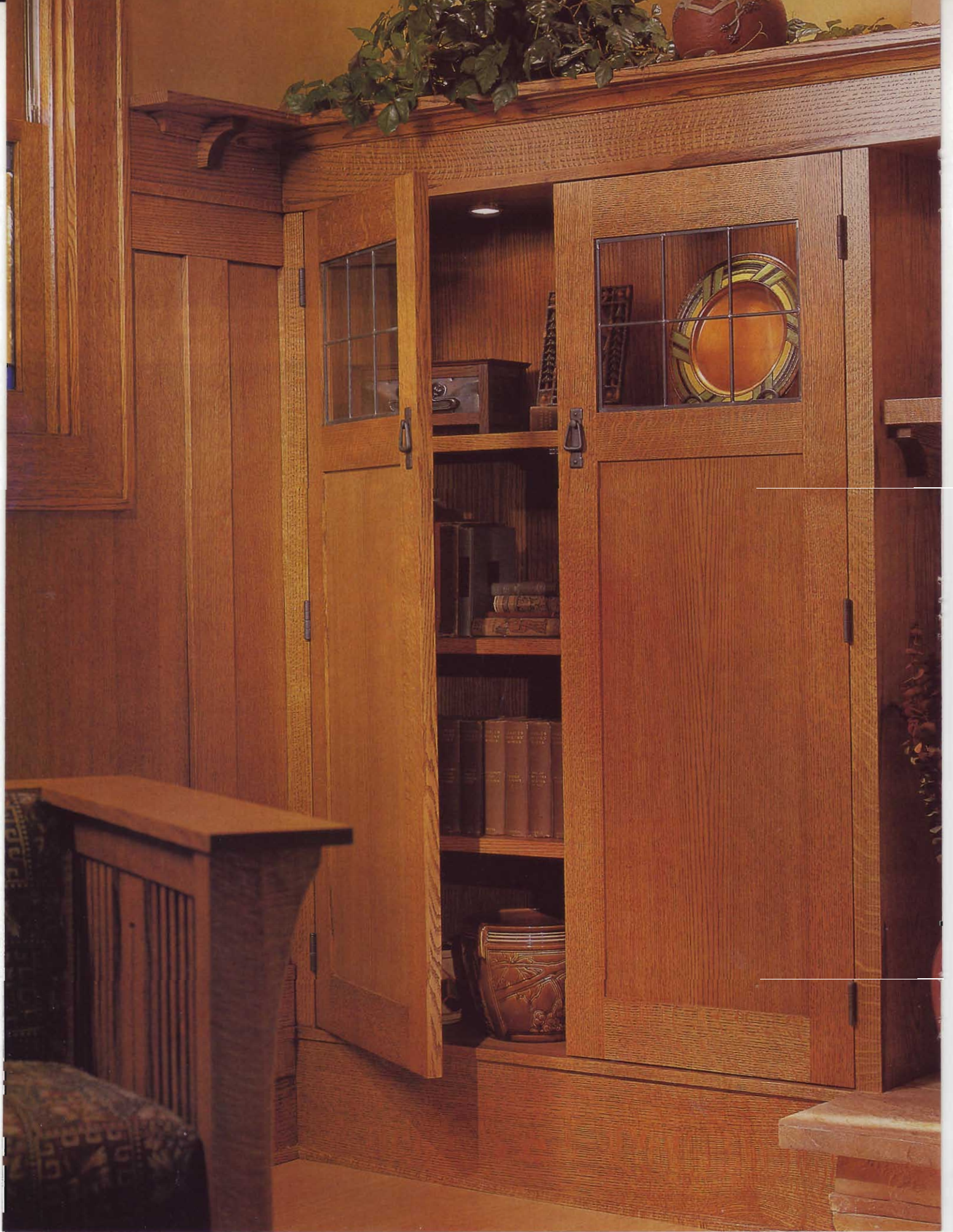

FAMILY ROOM RENOVATION

built-in bookcase

This new edition to your home will speak volumes about your good taste

Take a look around your home. Chances are, you'll spot any number of ideal locations for a built-in bookcase like the one at

left. These rock-solid storage and display cases fill the void. They look great flanking a fireplace or entertainment center, tucked into a nook, or lining the walls of your home's study area. They're easy to make, and add lasting value to your home.

Note: We'll show you how to build the bookcase that fits into the space available in our handcrafted family room. You'll need to adjust some or most of the dimensions to fit your location. We used quarter-sawn oak and straight-grained oak plywood for an authentic Arts and Crafts look, but you can substitute other woods to match your home's interior.

First, build the cabinet case

1 Cut the cabinet sides (A), top and bottom (B), fixed shelf (C), and fixed-shelf edge banding (D). See the Bill of Materials for our dimensions.

Note: Before taking the next steps, check the 2x4 framed opening in your wall. If

the opening is plumb, level, and square, the outside dimensions of the case should be 1/8" smaller in width and length than the opening. It's a good idea to cut the back (E) to size and check if it will fit into the opening before proceeding.

2 Mark the positions of the grooves for the shelf standards, where shown on the Side View drawing. Use a straightedge, router, and 5/8" straight bit set 3/16" deep to rout the grooves. Be sure to stop the groove so the fixed shelf covers its rounded end.

3 Use a drill press and holesaw to cut the 2 1/8" holes for the lights, where shown on the Exploded View.

4 Adjust your biscuit joiner's fence so the machine cuts a centered slot in the edge of 3/4"-thick stock. Set its

shop

tip Sanding pencil marks off open-grained woods, such as oak, can be challenging. Our solution: Mark the biscuit positions on masking tape, then just peel away the tape before you clamp the joints.

built-in bookcase

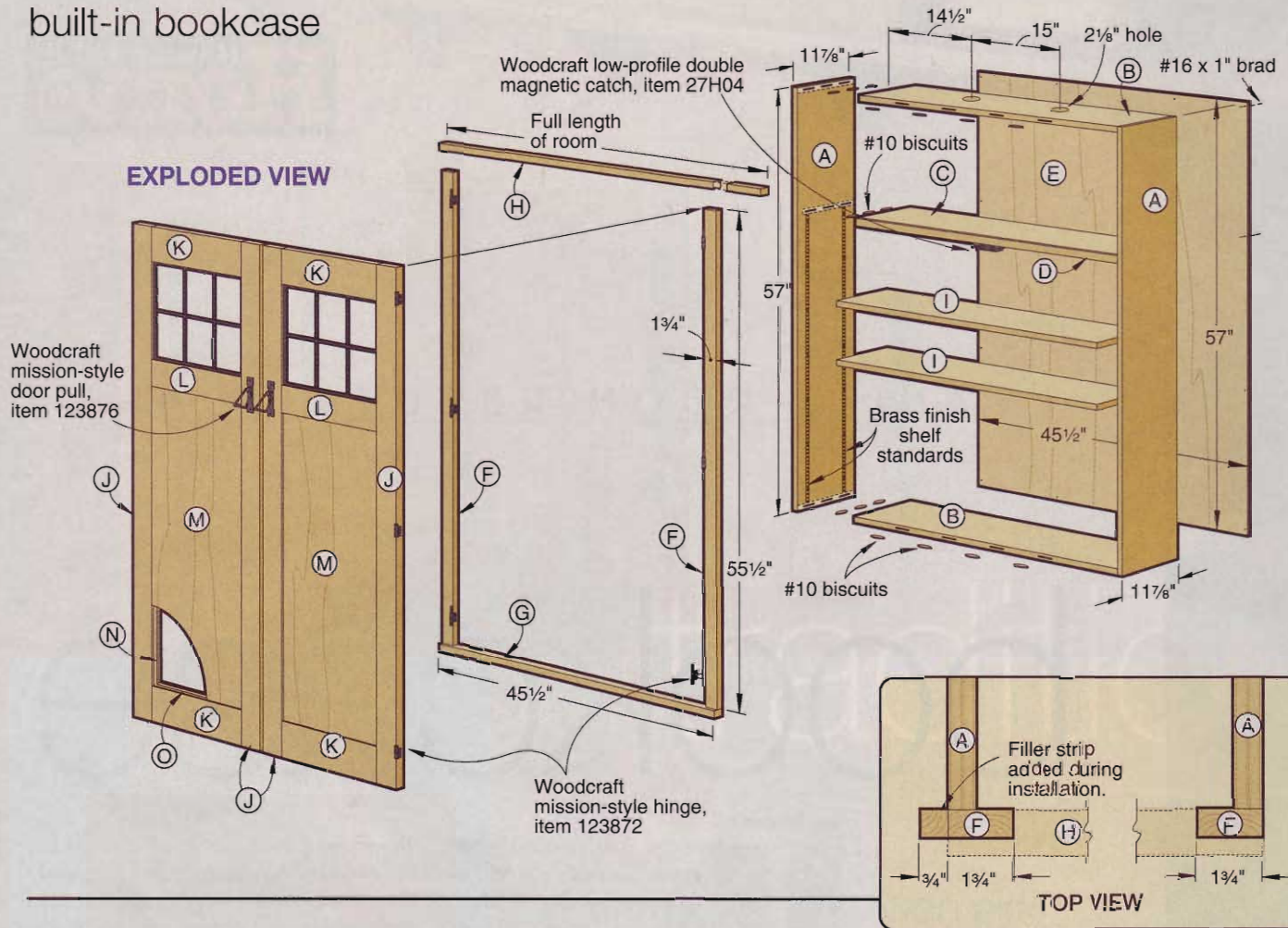

cutting depth for the #10 biscuits used throughout this project.

If you don't own a biscuit joiner, you can use rabbets and stopped dados, going with a slightly longer fixed shelf, top, and bottom.

5 Cut the biscuit slots for joining the ends of the sides (A) and tops and bottoms (B), as shown in *Drawings 1 and 2, below.*

6 Cut biscuit slots for joining the fixed-shelf edge banding (D) to the fixed shelf (C). Next, cut the slots for joining the fixed shelf to the sides, as shown in *Drawing 3, below.* To do this, use the fixed shelf as a reference and straightedge for aligning and positioning the slots in the sides (A).

7 Glue and clamp the edge banding to the fixed shelf. Then, glue and

clamp together parts A, B, and C/D, checking for square.

8 Bill of Materials, making sure it is square. Lay the A/B/C/D assembly on its front face and attach the back with 1" brads. (If you prefer air guns, use 1" narrow-crown staples. Air-driven brads will not hold the back sufficiently.)

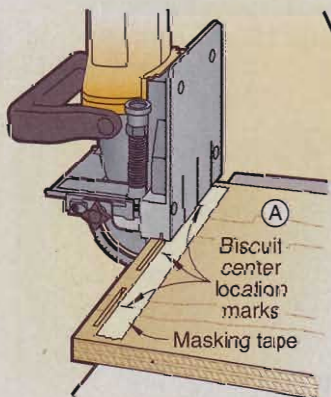

DRAWING 1
Cutting biscuit slots near the ends of the sides

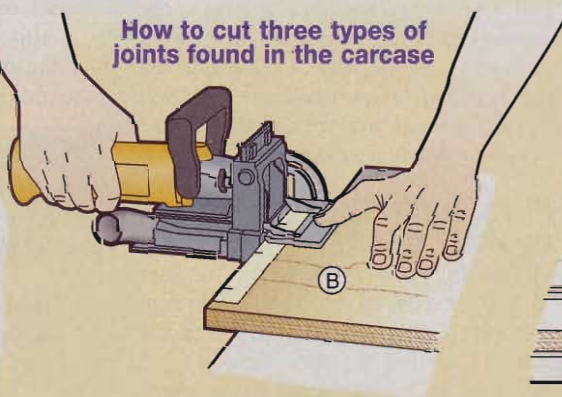

DRAWING 2
Cutting biscuit slots in the ends of the tops and bottoms

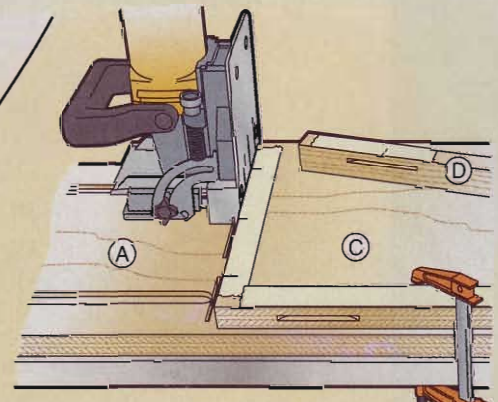

DRAWING 3
Cutting biscuit slots in the sides for receiving the fixed shelf

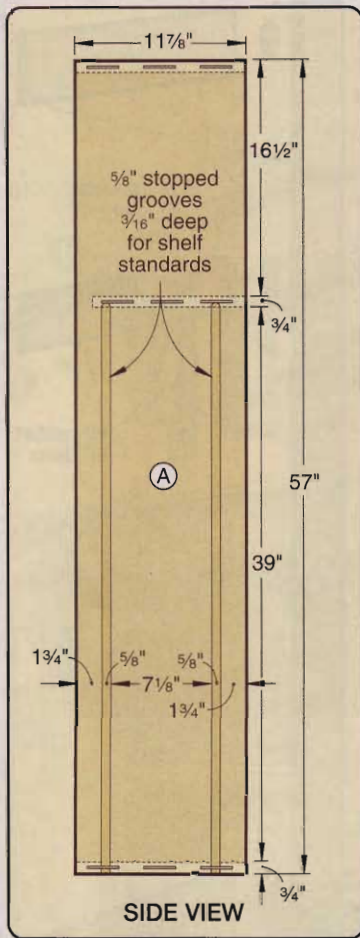

As shown in the Top View, we made one of the vertical face frames $\frac{3}{4}$ " wider than the other so we could scribe it to fit the wall (more on that later).

10 Cut the adjustable shelves (I) to size. Set aside for now.

Let's swing into making the doors

Note: Before cutting your door stiles and rails in the next step, check the size of the face-frame opening. Allow for these clearances: $\frac{3}{32}$ " between the doors and the face frame along the hinged edges, $\frac{1}{8}$ " at the tops and bottoms of the doors, and $\frac{1}{16}$ " between the doors.

1 From $\frac{5}{4}$ stock cut the door stiles (J), upper and lower door rails (K), and center door rails (L) to size. Because $\frac{5}{4}$ quarter-sawn oak is hard to find, we laminated $\frac{4}{4}$ boards and planed the laminations to 1" thick.

2 Mark the locations where the rails and stiles meet. Cut two slots for #10 biscuits at each joint.

shop

tip To give doors good swinging clearance, and to prevent the hinges from binding, cut a 2° bevel along both long door edges. Cut the bevel so it removes material from the back side of the door edge, not the front.

9 Lay the assembled case on its back. Cut the vertical face frames (F) and lower trim (G) to size. Biscuit, glue, and clamp these in place. Cut the biscuit slots for the upper trim (H).

bill of materials

| built-in bookcase | | FINISHED SIZE | | | |
|----------------------------|-----------------|--------------------|---------------------|-------|------|
| Case Part | T | W | L | Matl. | Qty. |
| A sides | $\frac{3}{4}$ " | 11 $\frac{7}{8}$ " | 57" | OP | 2 |
| B top & bottom | $\frac{3}{4}$ " | 11 $\frac{7}{8}$ " | 44" | OP | 2 |
| C fixed shelf | $\frac{3}{4}$ " | 10 $\frac{3}{4}$ " | 44" | OP | 1 |
| D fixed-shelf edge banding | $\frac{3}{4}$ " | 1" | 44" | O | 1 |
| E back | $\frac{1}{4}$ " | 45 $\frac{1}{2}$ " | 57" | OP | 1 |
| F vertical face frames | $\frac{3}{4}$ " | 1 $\frac{3}{4}$ " | 55 $\frac{1}{2}$ " | O | 2 |
| G lower trim | $\frac{3}{4}$ " | 1 $\frac{1}{4}$ " | 45 $\frac{1}{2}$ " | O | 1 |
| H upper trim | $\frac{3}{4}$ " | 1 $\frac{1}{4}$ " | * | O | 1 |
| I adjustable shelves | 1" | 11 $\frac{1}{4}$ " | 43 $\frac{1}{16}$ " | LO | 2 |
| Door Part | T | W | L | Matl. | Qty. |
| J door stiles | 1" | 3" | 55 $\frac{1}{4}$ " | LO | 4 |
| K upper & lower rails | 1" | 3 $\frac{7}{8}$ " | 14 $\frac{7}{8}$ " | LO | 4 |
| L center door rails | 1" | 3" | 14 $\frac{7}{8}$ " | LO | 2 |
| M door panels | $\frac{1}{2}$ " | 15 $\frac{1}{4}$ " | 34" | LP | 2 |
| N vertical panel stops | $\frac{1}{4}$ " | $\frac{1}{4}$ " | 34 $\frac{1}{8}$ " | O | 4 |
| O horizontal panel stops | $\frac{1}{4}$ " | $\frac{1}{4}$ " | 15 $\frac{3}{8}$ " | O | 4 |
| P vertical glass stops | $\frac{1}{4}$ " | $\frac{3}{8}$ " | 11 $\frac{3}{8}$ " | O | 4 |
| Q horizontal glass stops | $\frac{1}{4}$ " | $\frac{3}{8}$ " | 15 $\frac{3}{8}$ " | O | 4 |

*Upper trim runs full length of room across both bookcases, and is installed after the bookcase is in place.

Materials Key: O—oak, LO—laminated oak, LP—laminated plywood, OP—oak plywood.

Supplies: #10 biscuits, 48" brass-finish shelf standards (4), shelf clips with nails (8), $\frac{3}{4}$ " brad nails, 1" brad nails, stain, clear finish.

Buying Guide: Hinges, magnetic catch, and door pulls. Mission-style hinges, item 123872, \$10.50 per pair; low-profile double magnetic catch, item 27H04, \$1.99; Mission-style vertical door pull, item 123876, \$5.99. Prices do not include shipping charges. Contact Woodcraft, P.O. Box 1686, Parkersburg, WV 26102-1686. Call 800/225-1153, or go to www.woodcraft.com.

Low-profile halogen lights. Three-light kit with transformer, brass finish, item 44290, \$69.99 plus shipping. Contact Rockler, 4365 Willow Drive, Medina, MN 55340. Call 800/279-4441, or go to www.rockler.com.

cutting diagram

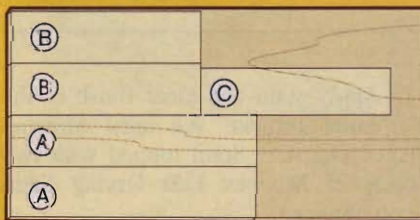

$\frac{3}{4}$ x 48 x 96" Oak plywood

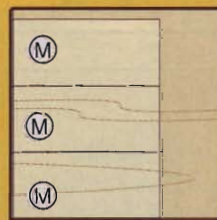

$\frac{1}{4}$ x 48 x 48" Oak plywood

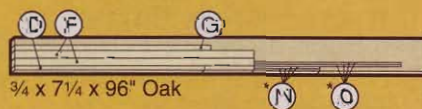

$\frac{3}{4}$ x 7 $\frac{1}{4}$ x 96" Oak



$\frac{3}{4}$ x 11 $\frac{1}{4}$ x 96" Oak (2 needed)



$\frac{3}{4}$ x 1 $\frac{1}{4}$ " x Width of room Oak

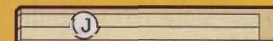

$\frac{3}{4}$ x 7 $\frac{1}{4}$ x 60" Oak (4 needed)

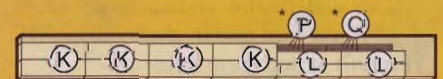

$\frac{3}{4}$ x 9 $\frac{1}{4}$ x 96" Oak

*Plane or resaw to thickness listed in the Bill Of Materials.

built-in bookcase

DRAWING 4
Using spacers to position center door rail

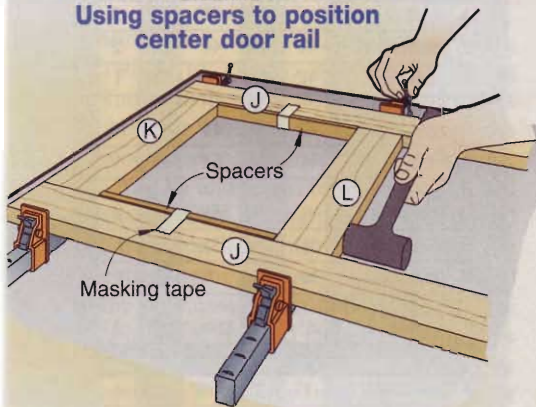

3 Assemble the doors with glue, biscuits, and clamps. Keep the door flat by working on a flat work surface, and check the glue-up for square by measuring diagonally. To precisely space the center door rails, use spacers, as shown in *Drawing 4*.

4 With a router and bearing-piloted rabbeting bit, cut a $\frac{1}{4}$ " rabbet, $\frac{3}{4}$ " deep around the inside openings of the door.



Make the cut in three successively deeper passes, as shown in *Photo A*. For the most chip-free results, move the router counterclockwise (known as a "climb cut"). Square the corners with a chisel.

5 Laminate the door panels (M) from two pieces of $\frac{1}{4}$ " plywood. (We laminated these because of the difficulty of finding $\frac{1}{2}$ " plywood with two good faces.) Place the panels in their openings.

6 Cut the vertical panel stops (N) and horizontal panel stops (O) to fit the panel opening. Miter their ends and secure in position with $\frac{3}{4}$ " brads.

7 Cut and fit the vertical glass stops (P) and horizontal glass stops (Q). You will attach them later.

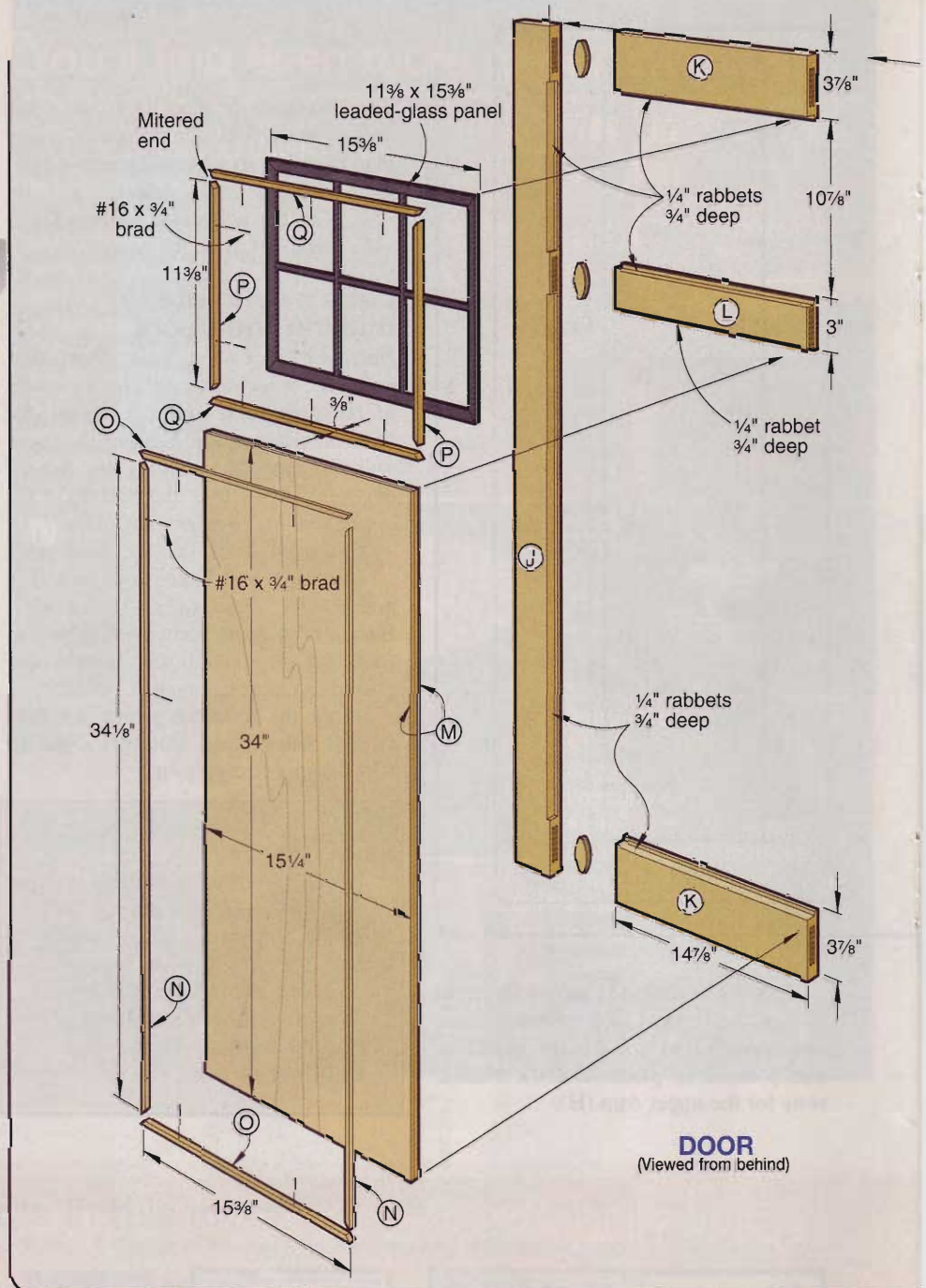

shop tip

Narrow stops, like the $\frac{1}{4} \times \frac{1}{4}$ " ones used to hold the door panels in this project, can split easily when you drive a brad through them. To prevent that from happening, drill pilot holes through the stops with a like brad. Or, attach the stops with a pneumatic brad nailer—these rarely split wood.

8 Apply stain and clear finish to the entire project. We used Minwax Aged Oak Gel Stain topped with two coats of Minwax Fast Drying Satin Polyurethane.

Now, install the cabinet into your wall

1 Attach the 2× blocking needed to hold the cabinet securely in position. (See how we supported the cabinet in the cutaway view on page 49.)

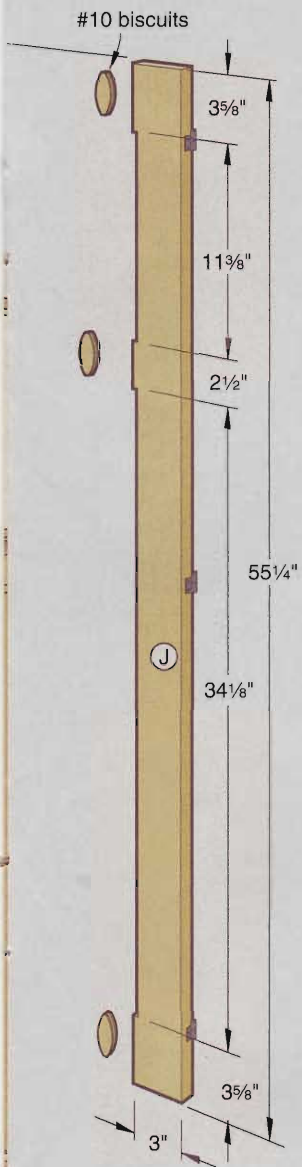

shop tip Here's a quick and easy way to fit cabinet face frames to walls. All you need are two 1/2"-thick scraps of wood and a pencil. First, use one scrap spacer to distance the cabinet face frame a maximum of 1/2" from the wall at any point along the face frame. Then, use the other 1/2" spacer and a pencil to scribe the wall contour onto the face frame or a filler strip edge-glued to the face frame, as shown in *right*. (In this instance we used a filler strip to fill the void between the edge of the face frame and the wall panel.) Simply plane or cut along the scribed line for a perfect fit to the wall.



2 Slide the cabinet into its opening, as shown in *Photo B*. Temporarily position the doors in the openings with spacers to set the clearances. Check the squareness of the case against the doors and shim around the edges of the case to make it fit the doors. The case should sit plumb and level.

3 Scribe the vertical face frames to fit adjoining walls. In the case of our cabinet, we had to place a 3/4"-wide filler strip between the wall and face frame, as shown in the Shop Tip Photo above, and scribe it to fit the wall.

4 Place the bookcase back into its opening. Secure it by driving nails through the cabinet sides or face frames and into surrounding blocking or other sturdy supports. We secured our bookcase with nails driven into the base board directly below the bottom front edge of the cabinet, as well as into the framing directly above the top front edge of the cabinet.

5 Install the light fixtures. We used low-voltage fixtures with long-life halogen bulbs. (See the Buying Guide on page 63 for a source.) The article on page 49 shows where we placed the wiring and transformers. Plug the transformers into switched power outlets.

6 Glue, biscuit, and nail the upper trim (H) in place.

Attach the doors

1 Mark the locations of the top and bottom hinges onto the door, where shown on the Door drawing. Center the middle hinge between the top and bottom hinges. Attach the non-mortise hinges with the supplied screws.

2 Position the doors in the cabinet opening, and place 1/8"-thick spacers underneath them. Transfer the locations of the hinges onto the vertical face

frame, as shown in *Photo C*. Attach the other halves of the hinges to the face frame at the marked locations.

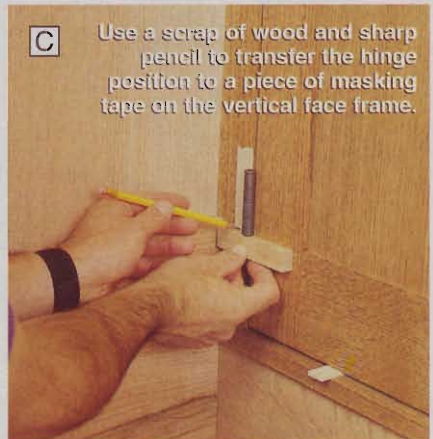

3 Lift the doors off the installed hinges. Attach the door pulls and magnetic catch, where shown on the Exploded View drawing.

A few final touches, and you're done!

1 Cut the brass-finish shelf standards to length with a hacksaw, and nail them into the 5/8" grooves in the cabinet sides. Use a needle-nose pliers to hold the tiny shelf-standard nails as you drive them with a hammer.

2 Place the shelf clips where desired, and install the adjustable shelves.

3 Secure the 11 3/8 x 5 3/8" glass panels with the P and Q stops and 3/4" brads. We used a leaded-glass panel to accentuate the Arts and Crafts look of the bookcase, but a single pane of glass would work fine. Hang the doors—that's it. 🛠️

Written by Bill Krier with Charles I. Hedlund
Photographs: Wm. Hopkins; Marty Baldwin
Illustrations: Kim Downing; Roxanne LeMoine

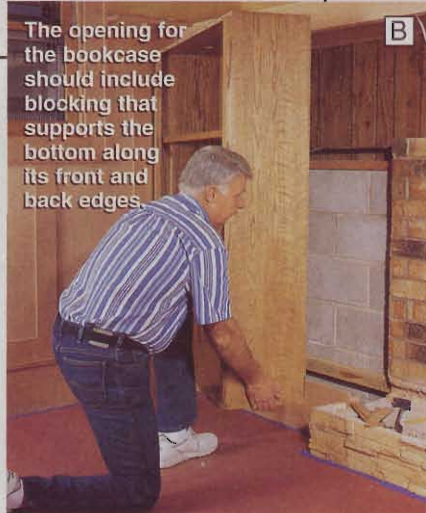

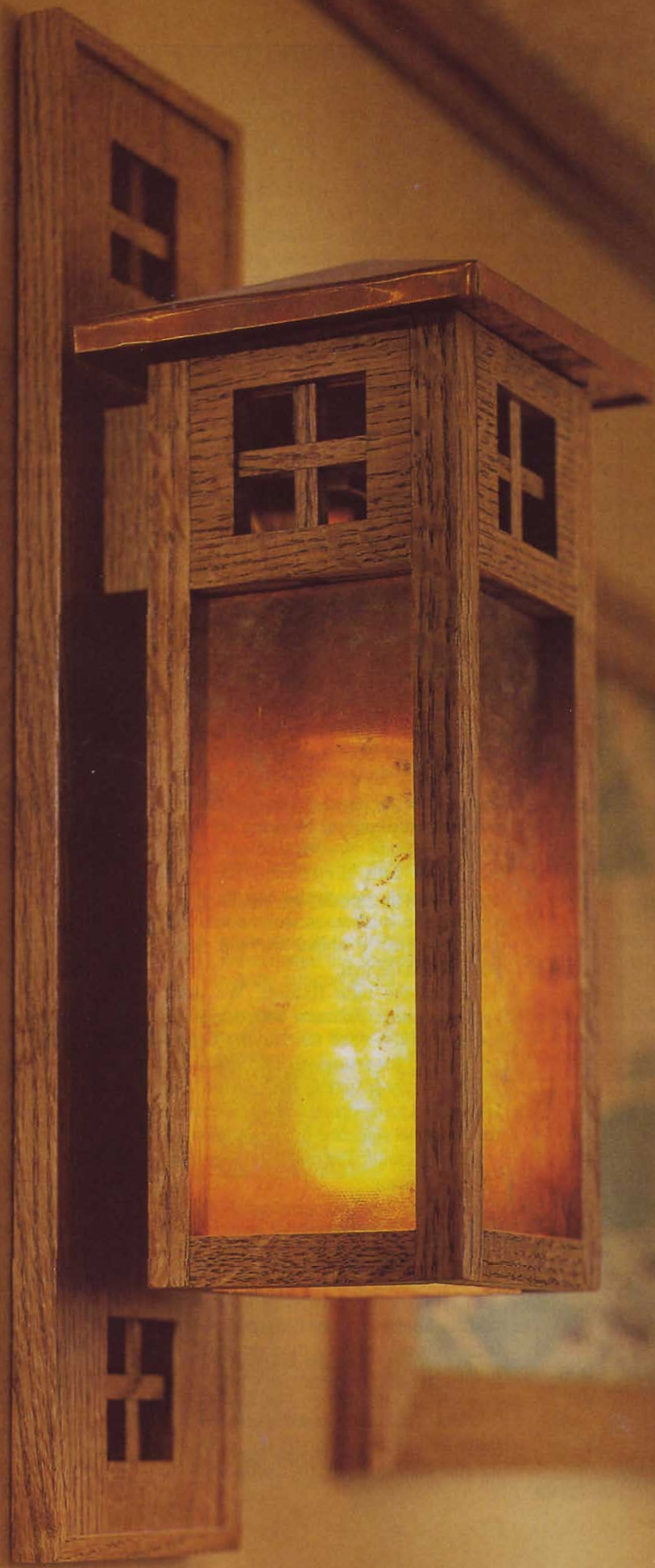

FAMILY ROOM RENOVATION

arts & crafts wall sconces

Matching accessories tie the entire room together into a harmonious package

The warm, golden glow of an incandescent light-bulb shining through a sheet-mica diffuser is a hallmark of Arts and Crafts lighting. Add this ambience to your home with one or more of these oak and copper wall-mounted sconces.

Start with the sconce's lantern

Note: To accommodate the different thicknesses of stock required for this project, select a 3/4x4 1/4x96" board. Cut a 12" length, and plane it to 1/2" thick for the G parts. Cut a 52" length, and plane it to 3/8" thick for parts A, D, E, F, I. Plane the remaining 32" piece to 1/4" thick for parts B, C, H, J, K, L.

1 From the 3/8" stock, cut the lantern panels (A) to the size listed in the Bill of Materials. Install a 1/4" dado blade in your tablesaw. Cut the grooves and dados in the backs of the pieces, as shown in Step 1 on the Lantern Panel detail of the Lantern Light drawing.

2 Now, rip and crosscut the lantern panels, as shown in Steps 2 and 3 of the Lantern Panel detail. Discard the waste square, and glue and clamp the remaining pieces of the panel together, as shown in Step 4.

3 From the 1/4" stock, cut the horizontal and vertical mullions (B) and (C) to size. Using your 1/4" dado blade, cut the centered notches in the mullions for the half-lap joints, as shown on the Lantern Panel detail. Set two of the horizontal mullions (B) aside for use later on the escutcheon panel (I). Glue the mullions into the lantern panels.

4 From the 3/8" stock, cut a 4x9 1/2" blank for the stiles (D) and a 2 1/4x3 1/2" blank for the rails (E). Install a dado blade in your tablesaw, and cut the 2 1/2" and 1/2" rabbets in the ends of the stiles blank, and the 1/2" rabbets in the ends of the rails blank and the lantern panels (A). The rabbets cut in these parts become the half-lap joints shown on the Lantern Light drawing. Rip the stile blank into 1/2"-wide strips



lantern wall sconces

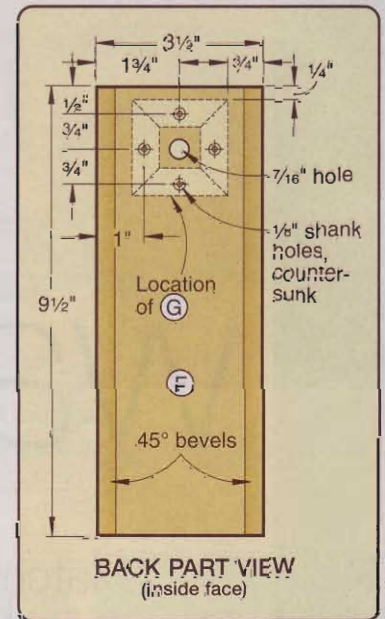
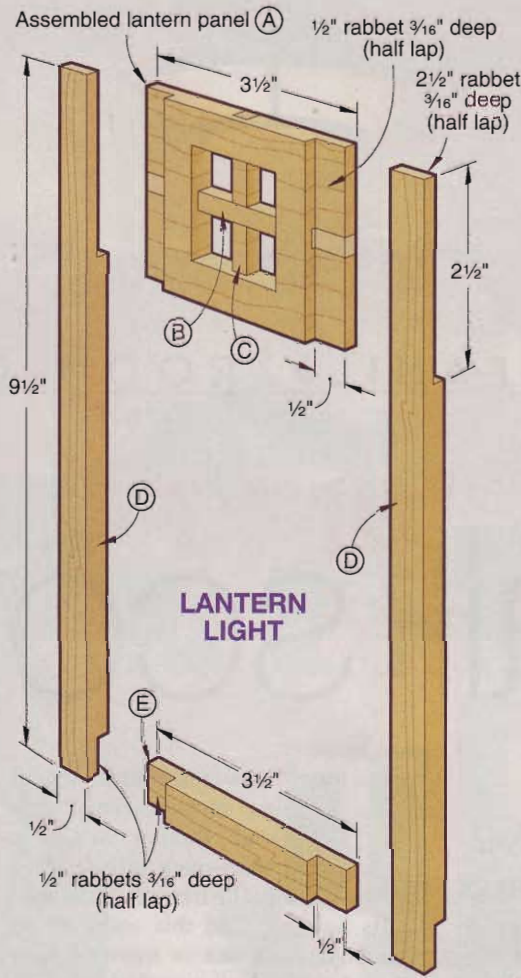
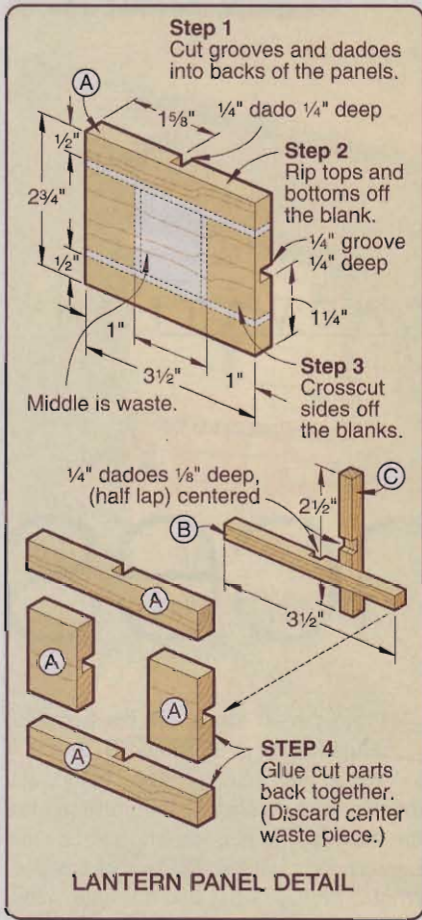

to form the stiles (D), as shown in Photo A. Repeat this operation with the rail blank to form the rails (E).

5 Glue and clamp together the lantern panel assembly (A/B/C), the stiles (D), and the rails (E) to form the lantern lights.

6 From the 3/8" stock, cut the back (F) to the size listed. Drill the counter-sunk shank holes and the 7/16" hole, as shown on the Back Part View drawing.

7 Tilt your tablesaw blade to 45°. With the fence positioned so the blade tilts away from it, bevel-rip the lantern lights and the lantern back (F), as shown on the Exploded View drawing.

Wrap up the lantern

1 Rip a 1"-wide strip from the 1/2"-thick stock for the mounting ring segments (G). Miter-cut them to the length listed. Glue the ring together, as shown on the Exploded View drawing.

2 Adhere the mounting ring to the outside face of the lantern back (F) with double-faced tape, where shown on the Back Part View drawing. Using the previously drilled holes in the lantern back (F) as guides, drill screw pilot holes in the mounting ring. For accurate reassembly later, make index marks on the ring and back. Remove the ring and set it aside.

3 Position the three lantern lights and the back, outside faces up, on a flat surface so the points of the beveled edges are touching and the top and bottom edges are aligned. Fasten the parts together, top, bottom, and center, with strips of masking tape. Turn the taped-together parts over, and spread glue on the beveled edges. Roll up the assembly, and secure the closing miter with more tape. Wipe off any glue that squeezes out, and set the assembly aside.

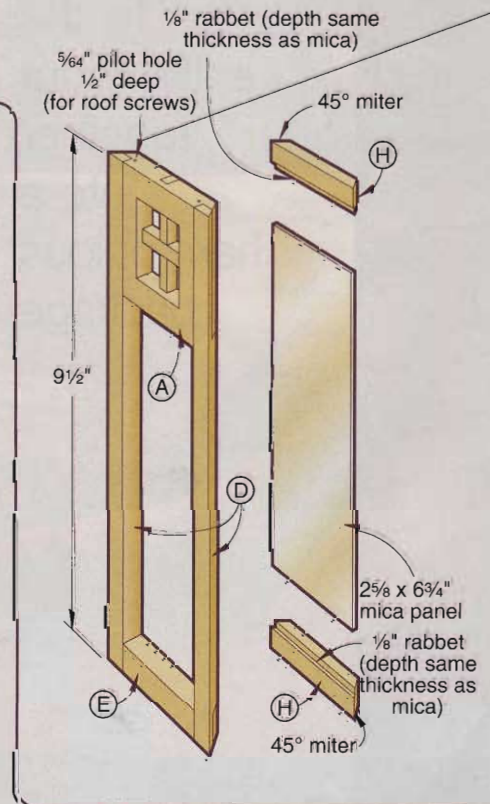

bill of materials

Note: All boards are cut and planed from one 3/4 x 4 1/4 x 96" piece of white oak.

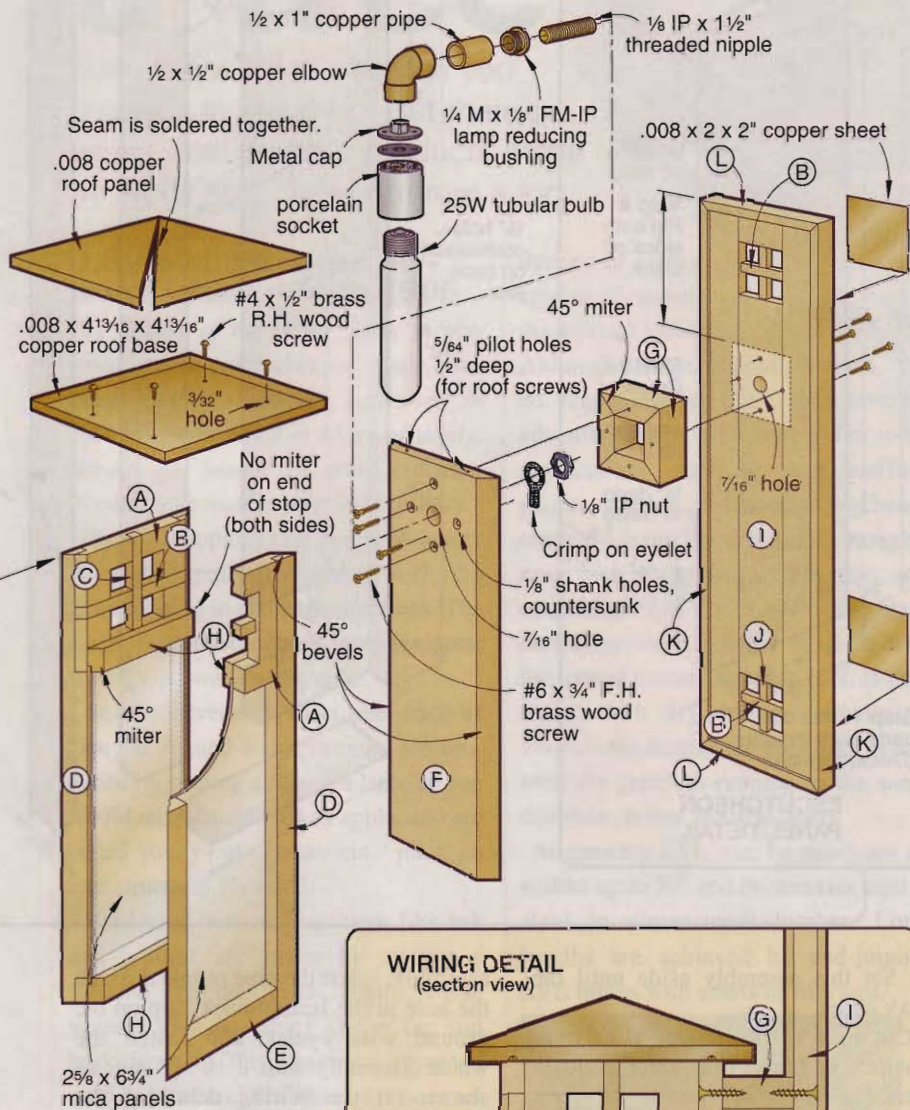
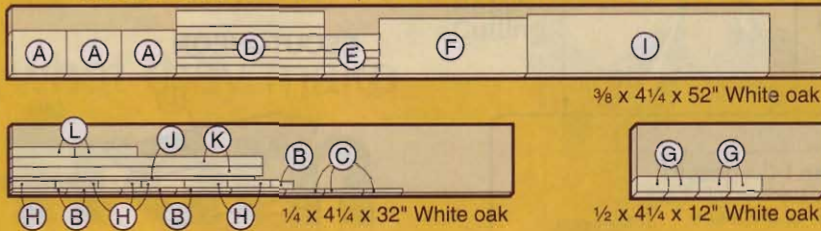

EXPLODED VIEW

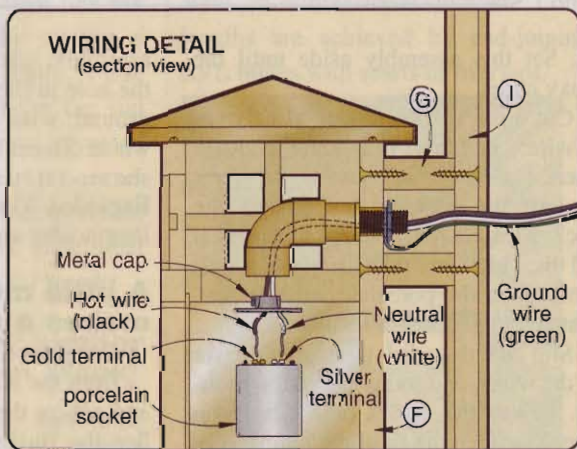

WIRING DETAIL
(section view)

bill of materials

wall sconces

| Part | FINISHED SIZE | | | Mat. | Qty. |
|-----------------------|---------------|--------|---------|------|------|
| | T | W | L | | |
| A* lantern panels | 3/8" | 2 3/4" | 3 1/2" | O | 3 |
| B horizontal mullions | 1/4" | 1/4" | 3 1/2" | O | 5 |
| C vertical mullions | 1/4" | 1/4" | 2 1/2" | O | 3 |
| D** stiles | 3/8" | 1/2" | 9 1/2" | O | 6 |
| E** rails | 3/8" | 1/2" | 3 1/2" | O | 3 |
| F lantern back | 3/8" | 3 1/2" | 9 1/2" | O | 1 |
| G ring segments | 1/2" | 1" | 2" | O | 4 |
| H** stops | 1/4" | 1/2" | 2 3/4" | O | 6 |
| I* escutcheon panel | 3/8" | 3 3/4" | 15 1/2" | O | 1 |
| J escutcheon mullion | 1/4" | 1/4" | 15 1/2" | O | 1 |
| K** side banding | 1/4" | 5/8" | 16" | O | 2 |
| L** end banding | 1/4" | 5/8" | 4" | O | 2 |

*Initial size shown. Parts are smaller after machining.
** Parts initially cut oversize.

Material Key: O-oak

Supplies: #6x3/4" flathead brass wood screws (8), #4x1/2" roundhead brass wood screws (4), 25-watt frosted tubular lightbulb.

Buying Guide

Hardware kit for one sconce: .030 sheet mica, .008 copper sheet, 1/2x1" copper pipe, 1/2" copper elbow, 1/4x1/8" IP lamp reducing bushing, 1/8x1 1/2" IP lamp nipple, 1/8" IP lamp nut, porcelain lampholder, crimp-on eyelet, J-B Weld metal-filled epoxy, #18 fixture wire (10" each: black, white, green). Order kit #WS, \$31.50 ppd. for one sconce, \$59.95 for two. Schlabaugh and Sons Woodworking, 720 14th Street, Kalona, IA 52247, or call 800/346-9663.

4 Rip a 1/2x18" strip from the 1/4" stock for the mica stop (H). Cut a 1/8" rabbet the thickness of the mica panel on one edge, and cut the stops to length. Miter both ends of the front stops, and one end of the side stops, as shown on the Exploded View drawing. Glue and clamp the top three stops in place. Set the others aside.

Craft a matching escutcheon

1 From the 3/8" stock, cut the escutcheon panel (I) to the size listed. Now, in a process similar to that used to form the lantern side and front panels, follow the four steps shown in the Escutcheon Panel detail on the Escutcheon drawing to form this part. When glued back together, the panel has two dados and a groove to accept mullions (B, J) and a 1 1/2x1 1/2" cutout at each end.

lantern wall sconces

2 Cut the escutcheon mullion (J) from the $\frac{1}{4}$ " stock to the size listed. Form the two notches near each end, where shown on the Escutcheon drawing. Retrieve the set-aside horizontal mullions (B), and glue them and the escutcheon mullion in place.

3 Drill the countersunk screw shank holes and the $\frac{7}{16}$ " hole, where shown on the Escutcheon Part View drawing. The countersinks are on the back of the escutcheon panel.

4 Chuck a keyhole bit in your table-mounted router, and adjust it to cut $\frac{1}{4}$ " deep. Position the fence to center the bit on the width of the escutcheon panel. Clamp stopblocks to the fence to position the keyhole slots where shown. Switch on the router, and with the top of the panel against the right stopblock, lower it onto the running bit, then move it to the left until it contacts the other stopblock. Turn off the router, and wait for the bit to stop before sliding the panel back and lifting it from the bit. You need a separate stopblock setup to rout each keyhole slot.

5 Adhere the mounting ring to the front face of the escutcheon panel (I) with double-faced tape, where shown on the Escutcheon Part View drawing. Using the previously drilled holes in the panel as guides, drill screw pilot holes in the mounting ring. Make sure the index mark previously made on the ring is in the proper orientation. Remove the ring and set it aside.

6 From your $\frac{1}{4}$ " stock, rip strips $\frac{1}{2}$ " longer than listed for the side banding (K) and end banding (L). Miter-cut the parts to length, and glue and clamp them to the escutcheon panel, leaving a $\frac{1}{8}$ " overhang at both front and back, as shown on the Escutcheon drawing.

It's time to get wired

1 Cut a 1"-long piece of copper pipe, and epoxy it into a $\frac{1}{2}$ " copper elbow, then epoxy a $\frac{1}{4} \times \frac{1}{8}$ " IP reducing bushing into the open end of the pipe, as shown on the Exploded View drawing. Remove the metal cap from a lampholder's porcelain socket, and epoxy it into the open end of the elbow, as shown. We used JB Weld metal-filled epoxy because it is heat resistant and adheres well to metal. Be sure to orient the metal cap so the screws are accessi-

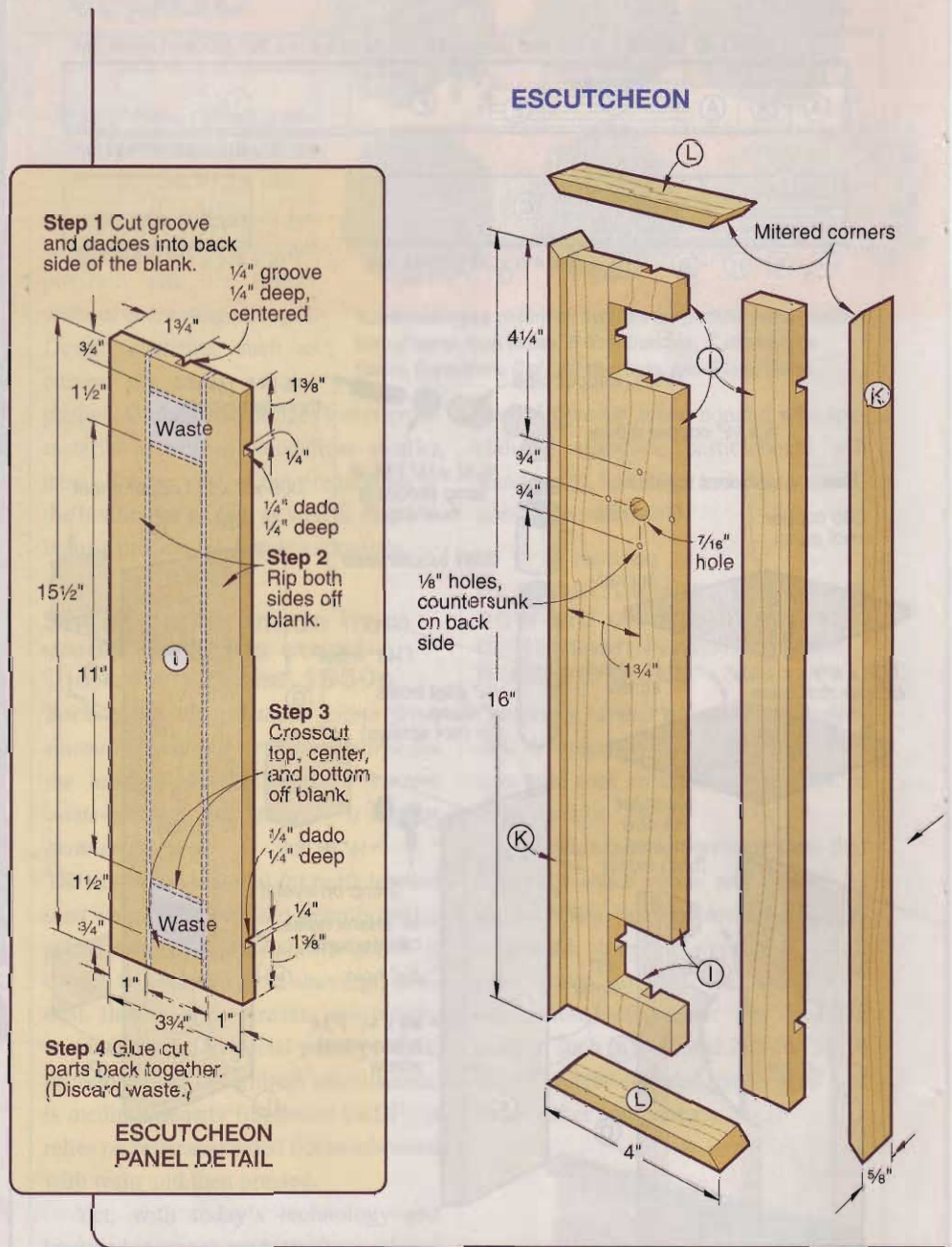

ble. Set this assembly aside until the epoxy cures.

2 Cut three 10" lengths of #18 fixture wire: one black, one white, and one green. Pull the black and white wires through the assembly. Connect the black wire to the gold (hot) terminal and the white wire to the silver (neutral) terminal on the porcelain lamp socket. Reattach the socket to its metal cap.

3 Slip the threaded pipe nipple over the wires, and screw it into the bushing. Crimp the eyelet onto the green wire. To check the fit of the lampholder

assembly, insert the pipe nipple through the hole in the lantern back, slip on the ground wire eyelet, and fasten the whole assembly with a $\frac{1}{8}$ " IP nut, as shown on the Wiring detail of the Exploded View drawing. Remove the lampholder assembly and set it aside.

A little metal work makes a roof

1 Copy the roof and roof base patterns from the *WOOD PATTERNS* insert, and adhere them to .008" copper sheet. See the Buying Guide for our source.

as elegantly simple as Stickley's. The pieces made in smaller shops or by individual woodworkers had many decorative details, such as inlays of ceramic tile, pearl, pewter, and exotic woods. In the case of Californians Greene and Greene, their furniture reflected an oriental influence. Yet, it is primarily Stickley's interpretations that have resurrected Arts and Crafts furniture for renewed popularity today.

An emphasis on native and natural

Quartersawn white oak was the chosen wood for most American Arts and Crafts furniture. It definitely was the staple for that produced by Gustav Stickley. The quartersawn wood was strong and durable. As a bonus, the stock displayed a ray figure that enhanced otherwise straightforward lines. Other native American woods, such as ash, chestnut, and even mahogany (Stickley offered it) also were used to some extent. English makers leaned toward darker flatsawn oak and mahogany.

In Great Britain as well as the United States, clear finishes were used to enhance the wood. In the Stickley factory, and in those of other American furniture makers, workers "fumed" the white oak to enhance its natural color and grain without muddying it. Fuming was done by placing the pieces inside a chamber with ammonia and leaving it there until sufficiently darkened. Aniline dyes then were employed to match sap-



Above: Quartersawn oak

Right: Hammered copper pull

wood to heartwood. Preferred shades were medium to dark brown, a stark contrast to the popular "golden oak" of the time. Even black and dark-greenish shades appeared.

Satin, not gloss, clear finishes were the choice for Arts and Crafts furniture. Stickley relied on quick-drying shellac mixed with German lacquer. A protective coat of wax usually was added.

Joinery as decoration

Woodworkers for centuries had employed the mortise-and-tenon joint, but it became a visual element of Arts and Crafts furniture. Extending the tenon through the furniture's surface—a table-

top, a chair, a leg—turned a structural element into a subtle, ornamental one.

At Stickley, Craftsman furniture first featured keyed tenons. But over the years of production they were replaced by less labor intensive, non-keyed, through tenons, then blind tenons. Shop-built Arts and Crafts furniture usually maintained the visual tenons, frequently shaped for interest.

Dowels, too, were visible when used for joining. They served to peg mortise-and-tenon joints.

Accents aid simple lines

Wooden brackets, called corbels, supported the wide arms of parlor chairs and other furniture, as well as wall-mounted shelves. However, these were purely accents, as the sturdy joinery did not require them.

Copper hardware, artificially aged and frequently hammered, served to enhance the dark oak prominent in the Arts and Crafts style. In England, German silver was popular. On the West Coast of the United States, Greene and Greene's work often included knobs and pulls of wood.

Upholstery materials for chair seats ranged from leather to rush. And leather occasionally was chosen to cover table tops and desk surfaces, but frequently was the upholstery of choice on sofas and settles.

Illustrations: Brian Jensen



JOINERY

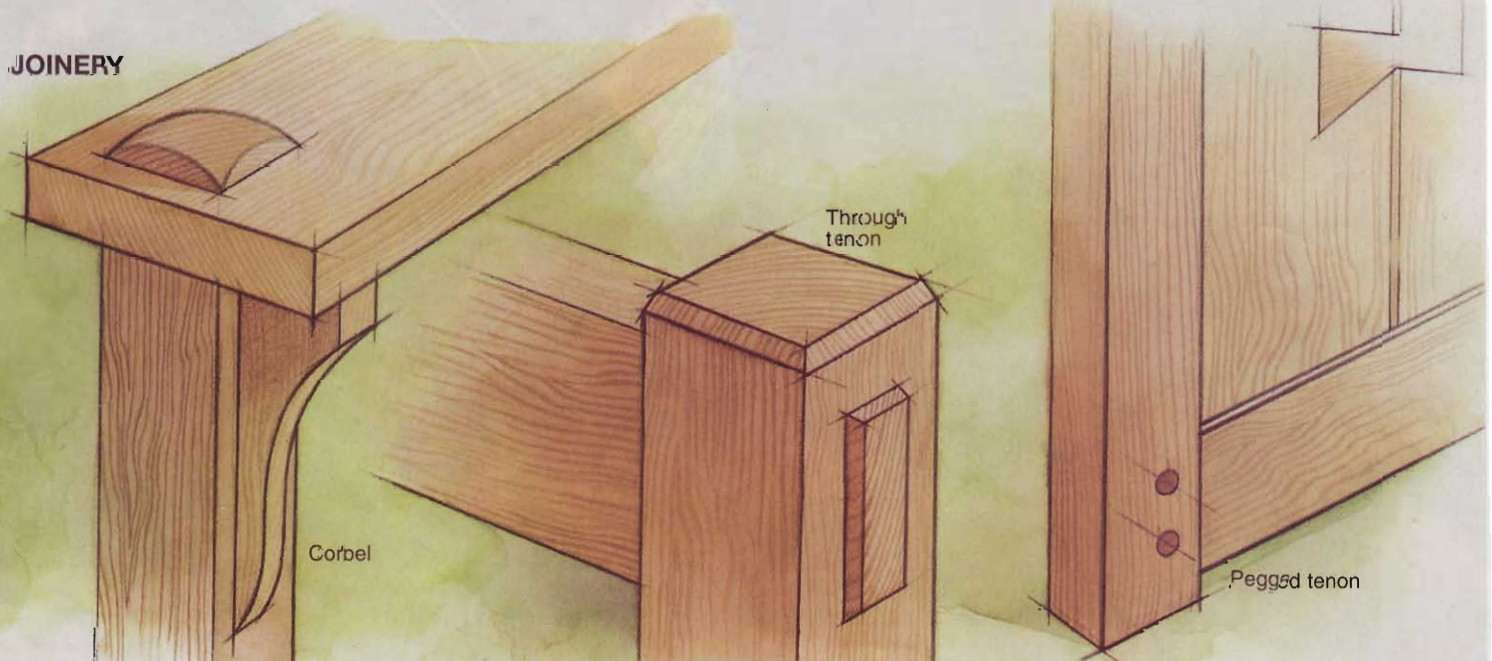

Corbel

Through tenon

Pegged tenon

call in

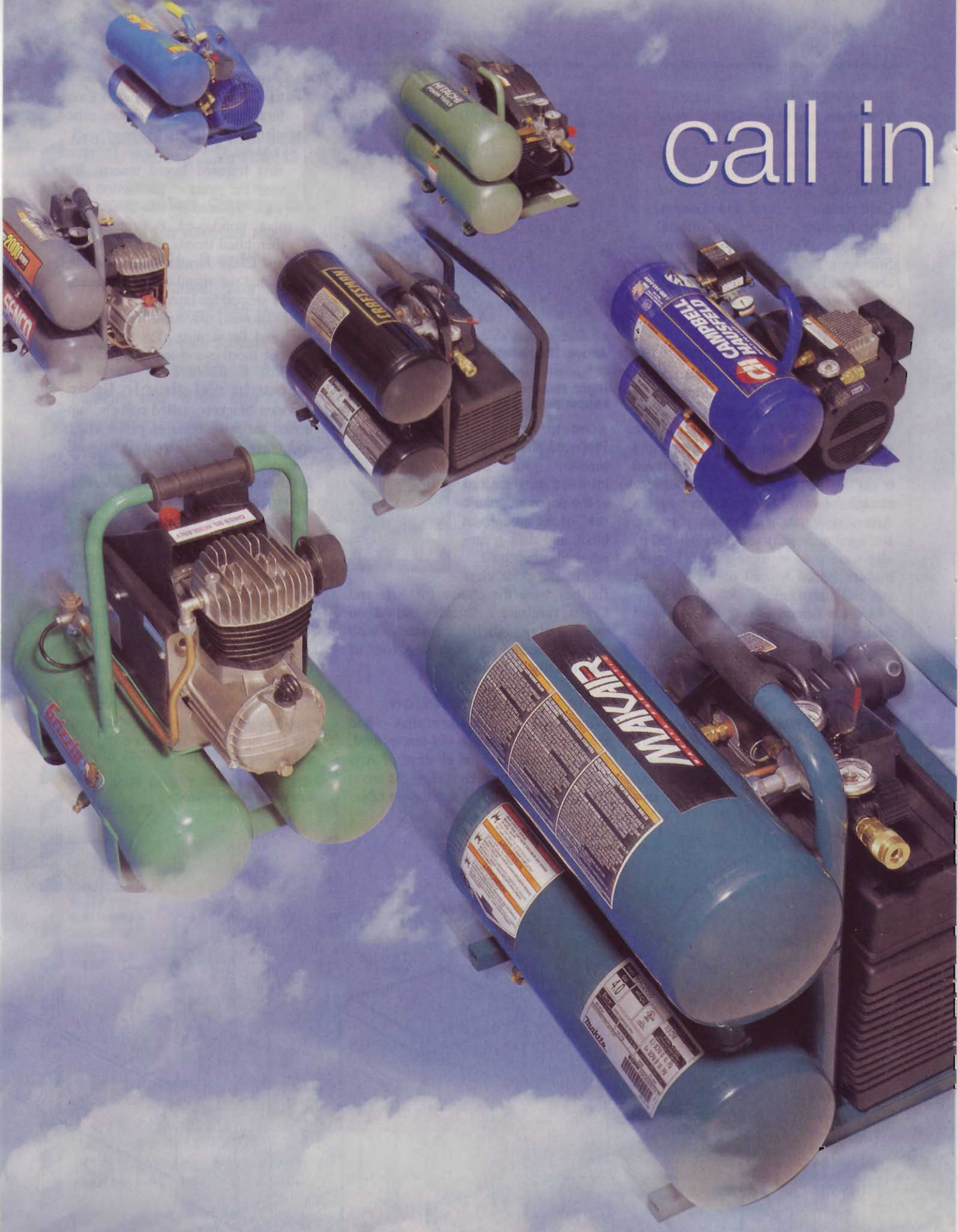

the air force

We put the pressure on seven compact compressors to find the top gun

Tools once used mainly in automotive and manufacturing facilities—air-driven machines such as nailers, spray guns, air brushes, impact wrenches, sandblasters, dust blowers, and tire inflators—are fast becoming mainstays in well-equipped home shops as well. Of course, the oomph for pneumatic tools has to come from a compressor—and because most of us have space and budget limitations, our tests focused on compressors that occupy only a few square feet and cost less than \$350. As a bonus, all can be transported for jobs away from your shop.

What we tested, and why

In our last test of air compressors (*WOOD*® magazine issue #69), we focused on hefty 3.5- to 6-horsepower machines that have lots of power, but also take up a lot of space. This time around, we looked at their little brothers—2-hp units small enough to tuck under a workbench. All are twin-tank, single-stage machines with carry handles and cast-iron cylinder heads. These smaller units can't handle big air-users like sanders and drills, but they

work fine with power nailers, for blowing dust off a project, and in some—but not all—spray-finishing applications.

Caution: Contents under pressure

A compressor's job is to produce, store, and deliver a given volume of air at pressure, measured in standard cubic feet per minute (SCFM). Manufacturers rate the amount of SCFM they can deliver at 90 pounds per square inch (psi), which is used as a constant because most air tools run effectively at that pressure.

Check the air requirements of your pneumatic tools using the chart, *above right*, or on the tool packaging. Then, compare that number to the SCFM ratings of the compressors in our test to see if they'll do the job.

For example, a brad nailer with a rating of 3 SCFM @ 90 psi would work well

Air Requirements

| TOOL | AIR CONSUMPTION |
|---------------------|------------------|
| Micro Die Grinder | 2 scfm @ 90 psi |
| Brad Nailer/Stapler | 3 scfm @ 90 psi |
| Die Grinder | 4 scfm @ 90 psi |
| Ratchet | 4 scfm @ 90 psi |
| Drill | 4 scfm @ 90 psi |
| Impact Wrench | 6 scfm @ 90 psi |
| Air Hammer | 6 scfm @ 90 psi |
| Jigsaw | 6 scfm @ 90 psi |
| Dual-action Sander | 16 scfm @ 90 psi |
| HVLP Sprayer | 5 scfm @ 40 psi |
| Siphon-feed Sprayer | 10 scfm @ 40 psi |

with any of the compressors in our test. A dual-action sander that needs 16 SCFM @ 90 psi, on the other hand, would easily starve a 2-hp compressor. None of our tested units can provide that quantity of air at 90 psi. Our units ranged from a low of 3.2 from the Craftsman 16745 to a high of 6.1 SCFM with the Makita MAC2200.

Fast Facts

- Compact compressors can power brad and finish nailers, lightweight staplers, caulking guns, and other light-duty shop tools. But for heavier applications, such as sprayers, sanders, and sandblasters, you'll need more airflow than these 2-hp machines can deliver.
- Four of these compressors are oil-lubricated, three are oil-free. Despite conventional wisdom, we found few performance differences between the two types.
- More importantly than the lube style, we found that high-rpm compressor motors are noisier and don't last as long as low-rpm motors.

small air compressors

Testing 1...2...3

Many woodworkers now use brad and finish nailers to greatly speed assembly of projects. To see how the compressors stack up in this popular operation, we set their regulators at 90 psi and drove 1" brad nails into 2x4 material with a single brad nailer, holding the trigger and firing nails until the compressor cut in. We did this three times with each machine, and averaged the results. The Craftsman fired a low of 33 nails and the Hitachi EC12 drove a high of 63.

Next, we wanted to see how long we could blow a stream of unrestricted air (such as you might do when blowing dust off your bench or unfinished project) before the compressor cut in. In the chart on page 79, we call this rating "duration of flow." Again, we timed each unit three times, and took the aver-

age. The shortest times came from Craftsman and the Grizzly G8297 at 7 seconds. Hitachi was the longest-winded machine at 12 seconds.

Finally, we put each compressor to the test spraying water-based polyurethane. First, we determined the pressure that best atomized the finish, then set each compressor to this specification. It turned out that 40 psi provided the best coverage with a pattern about 3" wide. Our testing revealed that a relatively small area could be effectively sprayed before the compressors reached cut-in pressures. At 143 square inches, the Senco PC2001 provided the best coverage area. The Makita and Campbell Hausfeld WL 5058 models provided the smallest coverage at 81 square inches.

This confirms HVLP manufacturers' admonitions about not spraying finishes with compressors that develop less than

3 hp. But we found that these units could satisfactorily spray small projects, such as jewelry boxes, children's toys, or picture frames, depending on the viscosity of the finish.

Lube styles: Is oil worth the toil?

The air compressors in our test fall into two mechanical categories: those that are oil-lubricated and those that aren't. Each system has pros and cons.

Like an automobile engine, oil-lubed compressors have a crankcase filled with oil. That lubricant splashes upwards, reducing friction between moving parts within the crankcase and cylinder block. This lessens wear on the components and helps them run cooler. Though all the compressors have aluminum pistons, the oil-splash models have steel cylinders or steel inserts in the cylinder walls,

A compressor's job: squash and deliver

The compressors in our tests differed in some details, but all use the same basic mechanics to compress air. An electric motor moves a piston up and down in a cylinder. On the down stroke, the piston pulls air in through an air-intake valve. At the bottom of the piston's stroke, the intake valve closes. As the piston moves up in the cylinder, it compresses the air, which then exits through an air-exhaust valve. Outlet piping moves the air past an open check valve into an air-holding tank.

When the pressure in the tank reaches a certain level, 125 to 135 psi, the compressor "cuts out" by shutting off the motor, and the check valve closes to trap air in the tank. As you use the air, the pressure drops to between 95 and 110 psi and the compressor "cuts in" again, thanks to a pressure switch that automatically restarts the motor at the factory-set cut-in pressure. The speed at which a compressor can cycle from cut-in to cut-out pressures—the cycle time—affects the efficiency of an air tool because it's frustrating to have to stop an operation and wait for the compressor to rebuild

pressure. We consider cycle times of less than 15 seconds excellent and times greater than 15 seconds good.

The pressure regulator controls the pressure of air to your tools, indicated on an air-pressure gauge. You adjust

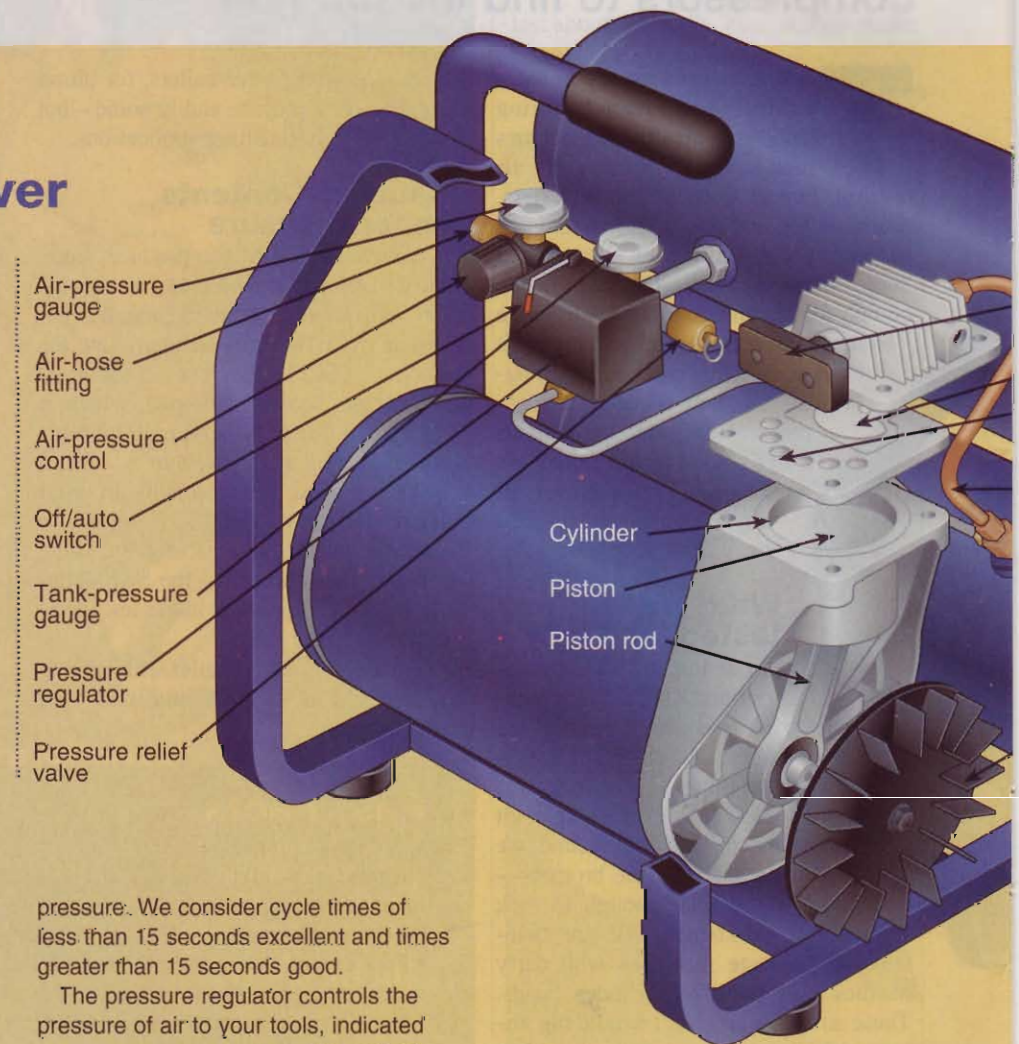

which should provide increased service life over oil-free units.

Oil-free compressors instead use Teflon-impregnated piston rings to reduce friction inside the cylinder walls. To keep their cool, these compressors have a fan-ventilated open crankcase like the one illustrated in the anatomy drawing below.

Oil-splash compressors run more quietly and last longer between pump rebuildings. They require regular maintenance, however, including checking and changing the oil according to the manufacturer's recommendations. Oil-splash machines must be operated on a relatively flat surface, so the oil can flow freely. And in spraying applications, you must filter air at the gun because traces of oil could sneak into the finish.

On the other hand, oil-free compressors need little regular maintenance and

can't contaminate spray finishes. However, they tend to make a louder and more irritating noise, and their open crankcase exposes the piston assembly to dust-related problems in a woodworking shop.

Mechanical matters

•**Speed kills.** Motor speeds in these compact compressors vary depending on whether the motors are wired with two- or four-pole electrical windings. Two-pole motors run at 3,450 rpm. These motors generally cost less and have a shorter service life than four-pole motors. Four-pole motors run at half the speed of two-pole units, and generally require less amperage.

Lower rpm translates into increased motor and head life, and quieter operation. The Grizzly had the lowest current draw at 12 amps, with the Emglo AM700HC4V a close second at 12.5 amps. The Makita unit required a 20-amp circuit because it repeatedly blew a standard 15-amp circuit.

Incidentally, these motors aren't meant to run continuously. Instead, they're designed to run 50 percent of the time, or about 30 minutes per hour of use. If the motor overheats, a thermocouple disconnects power. With three of the units we tested, you must press a manual reset to restore power after the motor cools. The Campbell Hausfeld, Craftsman, and Hitachi restore power automatically after the motor cools, which could catch you by surprise if you haven't turned the machine off.

•**Pipes is pipes.** The air-plumbing lines on these compressors are either copper or Teflon tubing. Copper dissipates heat more quickly, but it's hot to the touch and more easily damaged. Teflon lines easily snake through tight spots and can be bumped without denting.

As long as an air-line is well protected, what it's made of doesn't really matter. Exposed copper lines on the Senco and Grizzly units stand a good chance of damage, however, and could cause painful burns. Getting to the Grizzly's lower tanks probably accounts for its longer pipe run, shown in the *top right* photo. Here shielding or a Teflon material would make better sense. Based on our test results, Bill Crofutt of Grizzly Industrial has requested that the factory "either install a guard over the copper



Unprotected copper tubing on the Grizzly could burn you if you pick up the compressor when it's hot. It's also more prone to dings and damage than Teflon tubing on other models.

pipe, change to a material that better dissipates the heat, or insulate it."

•**You can rebuild it.** Given enough use, any of these compressors may ultimately require repair or rebuilding. In our neck of the woods, a typical rebuild on an oil-splash compressor runs about \$50, while the same level of service on an oil-free model costs about \$70. Depending on your mechanical aptitude, you may be able to do the job yourself. On both oil-free and oil-splash machines, overhauls involve replacing various O-rings and seals: not a difficult job as long as you put everything back where it belongs.

To dismantle a compressor, you need to remove the head bolts, and that can be a chore in some cases. With the Craftsman and Makita models, you first have to get at awkwardly placed screws holding the motor/fan shroud in place. The Emglo AM700HC4V requires a great deal of time and work to disassemble. Head bolts on the Campbell Hausfeld, Grizzly, Hitachi, and Senco units are easy to access.

Gauges and controls

All of the compressors we tested had a pair of gauges—one that tells the pressure at the outlet, another that registers air pressure remaining in the tank. Because you'll refer to these gauges fairly often, we feel readability is important, especially as we get older and our eyesight gets worse. We found that not all compact air compressor gauges are created equal in their readability.

The numbers on Hitachi's gauges are the smallest in the bunch, but we found

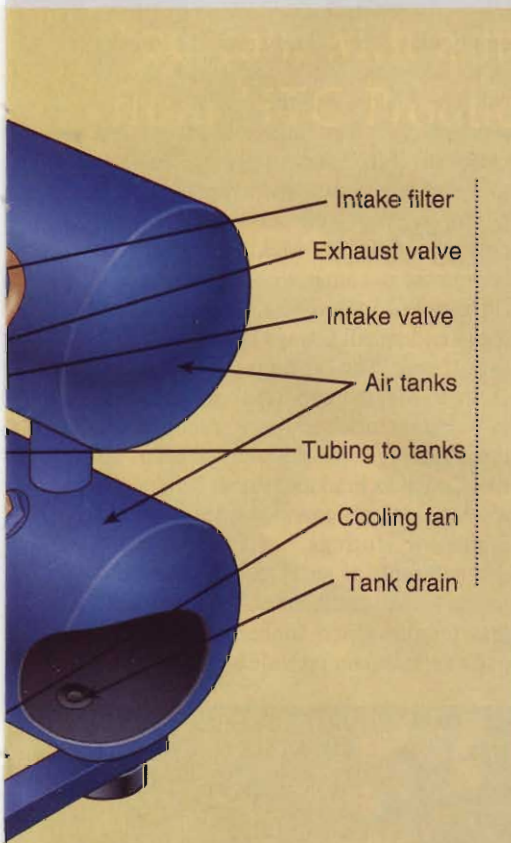

that pressure by turning an air-pressure control knob on the regulator. (Standard practice is to set the pressure you want by approaching the setting from a lower pressure and increasing it as necessary.)

small air compressors

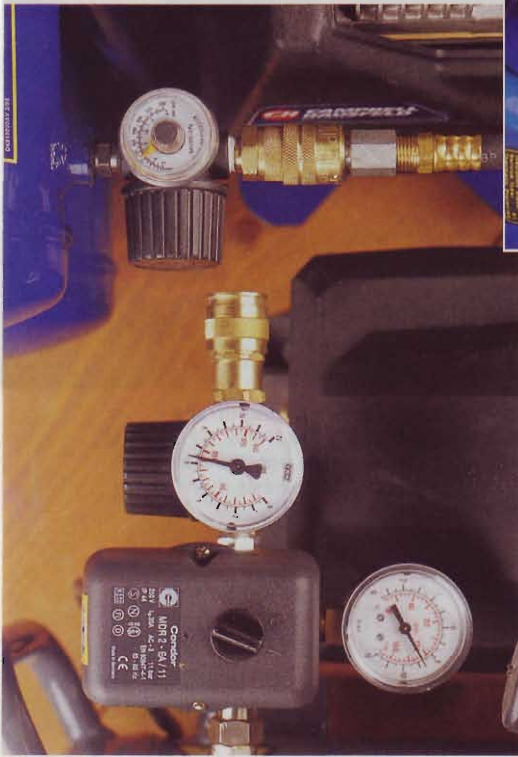

Campbell Hausfeld's combination of small numbers and small-diameter gauges the most difficult to read, as you can see in the photo above. A Campbell Hausfeld spokesman told us the gauges on their new line of compressors, due out this Spring, address this concern.

We prefer the nice, large 2" gauges on the Senco machine. Grizzly's gauges were plenty readable, but their location—near the floor, and facing out instead of up—meant we had to get on our hands and knees to read them. Again, after learning of our findings, Grizzly's Bill Crofutt asked his factory to "change the pressure gauges to either a 45- or 90-degree position from the current, so they are better visible."

To adjust the outlet air pressure you turn a knob clockwise or counterclockwise, and all but the Emglo were easy to operate. Here the problem is the carry-handle, which restricts your line of sight to the gauges and makes the regulator knob hard to get to (see top photo).

Some models, such as the Grizzly G8297 and Hitachi EC12, have a locking knob to keep a set pressure from unexpectedly changing. The Grizzly held its own very well, but we couldn't keep the Hitachi regulator from straying from the desired pressure setting.



Top photo: The handle on the Emglo unit partially obscures the output pressure gauge and makes the regulator knob hard to operate.

Left photo: We found Senco's large gauge faces and numbers (bottom) easier to read than the Campbell Hausfeld gauge (top).

More points to consider

•**Intake filters.** To work well, the compressor needs a clean, unimpeded flow of air through the intake valve. This means intake filters should be easy to clean and replace, especially in a dusty woodworking shop.

Filter media and housings varied widely. The Craftsman has a simple foam filter held loosely in a plastic shroud at the cylinder head. Emglo uses the same foam material as a medium, but the filter is shaped like a plug that fits into the motor shroud, a system that seems functional but not very sophisticated. Grizzly also uses foam, but it's housed in a plastic housing with multiple air holes.

Senco and Hitachi filters consist of a cotton-like material in plastic filter canisters. With the Campbell Hausfeld, the filter is a heavy felt.

Comparing all the models, we liked Makita's pleated-paper filter cartridge, shown below right, best. With its large surface area and fine filtration medium, it should provide cleaner air and last longer than the other systems.

•**Tank drains.** In times of high humidity, compressing ambient air causes water to accumulate in the holding tanks. The higher the humidity, the more often water must be drained from the tank. Draining helps protect the interior lining of the tank, and also reduces the

amount of moisture in the air stream. The Makita and Craftsman compressors have a single drain that empties both tanks at the same time. The others have a drain on each tank, so you have to take care to drain both tanks.

•**Noise.** As with any power tool, when you're working in a confined shop or garage, the noise a compressor makes can be an important issue. We placed each unit 5' from a wall, about the length of a power cord, and located a sound meter 15' from the compressor. The values listed in the chart are the highest levels sustained for more than five seconds. Generally, the sound level increased as each machine reached its maximum pressure. Units running at 1,725 rpm were quieter, and we liked the Grizzly at 70 decibels.

•**Fill-from-empty time.** If you use your compressor infrequently, you should empty the compressed air from the tanks periodically. We decided to see how long you would have to wait to fill an empty tank. The Grizzly took the longest at 88 seconds, but it also filled to 135 psi. The Makita had the fastest fill at 53 seconds. For this rating, we measured complete fill from empty to cut-out, sampled three times and averaged.

•**Fittings.** We were disappointed that only the Grizzly, Makita, and Senco compressors came with quick-connect fittings. With the others, we had to purchase and install fittings before we could use them. The fittings supplied by Grizzly, Makita, and Senco are standard 1/4" connectors, and we recommend these fittings for less-demanding air tools, such as brad and finish nailers and toy inflators. (Bigger 3/8" fittings, called high-flow fittings, suit such high-demand tools as spray guns, high-speed sanders, or sandblasters—applications that require much higher airflow than our test units can provide.)

Makita's pleated-paper air intake filter does a better job keeping debris out of the cylinder than the foam, felt, or cotton filters on the other machines.



PSSSST! HERE'S THE INSIDE STORY ON SEVEN COMPACT COMPRESSORS

| MANUFACTURER/ IMPORTER | MODEL | MOTOR | | CONSTRUCTION | | | | TANKS | | | PERFORMANCE RATINGS (6) | | | | | | | | | | COMMENTS | | | |
|---------------------------|-----------|-------|-------------|---------------------------|-----------------------|--------------------------------|---------------------|-----------------------------|------------------|-------------------------|-------------------------|------------------------|------------|----------------------|------------------|-------------------|-------------|---------------------------|--------------------------------|-----------------|----------|------------------|-------------------------|---|
| | | AMPS | SPEED (RPM) | THERMOCOUPLE RESET (1) | CYLINDER MATERIAL (2) | OIL-SPLASH OR OIL-FREE? (3) | PIPING MATERIAL (4) | TOTAL CAPACITY (GALLONS) | NUMBER OF DRAINS | AIR DELIVERY (SCFM) (5) | CUT-IN PRESSURE (PSI) | CUT-OUT PRESSURE (PSI) | CYCLE TIME | FILL-FROM-EMPTY TIME | DURATION OF FLOW | GAUGE READABILITY | PORTABILITY | NOISE LEVEL (DECIBELS) | QUICK DISCONNECTS INCLUDED? | WEIGHT (POUNDS) | | WARRANTY (YEARS) | COUNTRY OF ASSEMBLY (7) | SELLING PRICE (8) |
| CAMPBELL-HAUSFELD | WL5058 | 13.5 | 1,725 | A | AL | OF | TC | 4 | 2 | 4.3 | 95 | 125 | E | E | G | F | G | 75 | N | 72 | 3 | US | \$239 | A good all-around unit with the lowest price and longest warranty in the test. Small gauges are hard to read. |
| CRAFTSMAN | 16745 | 14.0 | 1,725 | A | AL | OF | C | 4 | 1 | 3.2 | 110 | 135 | G | F | G | G | G | 74 | N | 70 | 1 | US | 260 | 135psi maximum pressure is the highest in the test. Easy to read, well-placed gauges. |
| EMGLO | AM700HC4V | 12.5 | 3,450 | M | SL | OS | C | 4 | 2 | 3.2* | 100 | 125 | G | G | G | F | G | 79 | N | 60 | 1 | US | 270 | Carry-handle restricts access to regulator knob and blocks line of sight to gauges. |
| GRIZZLY | G8297 | 12.0 | 1,700 | M | CI | OS | TC | 4.25 | 2 | 4.2 | 105 | 135 | G | F | G | F | E | 70 | Y | 60 | 1 | IT | 312 | Well-balanced, excellent performing oil-splash unit. The quietest model in our test. 135 psi max. pressure. |
| HITACHI | EC12 | 15 | 3,450 | A | SL | OS | TC | 4.3 | 2 | 4 | 100 | 125 | G | G | E | F | G | 79 | N | 60 | 1 | IT | 275 | Small numbers make gauges difficult to read. |
| MAKITA | MAC2200 | 15.0 | 3,450 | A | AL | OF | C | 4 | 1 | 6.1 | 100 | 125 | E | E | E | G | G | 80 | Y | 69 | 1 | US | 329 | Big-time air delivery in a compact package, but requires 20-amp electrical service. |
| SENCO | PC2001 | 14.1 | 3,450 | M | CI | OS | TC | 4.3 | 2 | 4.3* | 95 | 125 | E | G | G | E | G | 80 | Y | 52 | 1 | IT | 299 | Large, easily read gauges. Very steady, easy to set regulator. |

NOTES:

- (A) Automatic
(M) Manual
- (AL) Cast aluminum
(CI) Cast iron
(SL) Cast iron with steel sleeve
- (OF) Oil-free
(OS) Oil-splash
- (T) Teflon
(C) Copper
(TC) Teflon and copper
- Standard cubic-feet-per-minute at 90psi, except where noted. (*) rating at 100psi
- E** Excellent
G Good
F Fair
- (US) United States
(IT) Italy
- All prices current at time of article's production and include shipping where applicable.

For more information, contact:

| | | |
|---|---|---|
| Campbell Hausfeld 888/247-6937 www.chpower.com | Grizzly Industrial 800/523-4777 www.grizzly.com | Makita 800/462-5482 www.makitatools.com |
| Craftsman Visit local Sears store. www.sears.com/craftsman/ | Hitachi 800/546-1666 www.hitachi.com | Senco 800/543-4596 www.senco.com |
| Emglo 888/883-6456 www.emglo.com | | |

•**Portability.** Although marketed as portable, “luggable” might be a better descriptor. These compressors are heavy, with oil-free models weighing 10–20 pounds more than oil-splash units. And, except for the Grizzly with its bottom-mounted tanks, that weight is poorly balanced because the motor side is much heavier than the tank side. We found it much easier to walk with the tank side against the body.

So, which should you choose?

If you were going to use your compressor in the harsh environment of a job site and wanted it to stand up to rough handling, you'd want a model with high SCFM and protection for gauges and regulators. Both the Craftsman 16745 and Makita MAC2200 can stand up to rough treatment, thanks to well-guarded piping and protective roll bars on the sides of the

machines. With a rating of 6.1 SCFM @ 100 psi, the Makita delivers the most air of the units we tested. And because these models are oil-free, you can use them on uneven surfaces without worrying about starving the pump's oil supply.

But if you want a general-purpose machine to use around the shop and home, noise level, portability, and amperage draw become important considerations. If you're willing to perform the maintenance on an oil-splash compressor, we especially liked the Grizzly G8297. By far the quietest at 70 decibels, it was also the highest pressurized unit at

135 psi, and its 12-amp requirement will operate on any household circuit.

If you prefer a maintenance-free, oil-free compressor, the Campbell Hausfeld WL5058 would be our choice. With a 13.5-amp draw, a respectable 4.3 SCFM rating, fast recycle, and three-year warranty, it would be a good addition to your shop. If you need more air delivery for spraying small projects, though, and can dedicate a 20-amp circuit to your compressor, go with the Makita.

Written by **Jim Hufnager**
Technical consultant: **Jim Heavey**
Illustration: **Troy Doolittle/TOPDOG Illustration**
Photographs: **Baldwin Photography**

Now go online and blow off some steam

We've had our say about these compact compressors. Now, it's your turn. Log into our **WOOD Online® Interactive Tool Flew** at www.woodonline.com, and share your thoughts with your fellow woodworkers in a special Compact Compressors discussion group. Not only that, but you'll learn how the manufacturers responded to this article.

twice-as-nice.
pivot



ing picture frames

Classic styling combined with your perfectly paired photos make an eye-grabbing display

Some of the best things in life come in twos. Moms and dads, brothers and sisters, your family and your spouse's family. This project suits these pairings to a T. The stand's timeless good looks complement any picture, and the pivoting frames add visual interest.

First comes the frame stand

1 Cut the $\frac{3}{4} \times 1\frac{3}{4} \times 15\frac{3}{4}$ " pediment (A). We chose walnut for all of the project parts. Other good choices include cherry or Honduras mahogany.

2 Copy the pediment full-size half pattern found in the *WOOD PATTERNS*® insert. Adhere the pattern to stiff card stock, and cut to shape with scissors. Trace the shape of the pattern onto the left side of A, then flop the pattern and trace it onto the right side. Bandsaw just outside of the marked lines. Sand to final shape.

3 Mark and drill the centered $\frac{3}{8}$ " finial hole $\frac{1}{2}$ " deep, where shown on the Exploded View drawing (next page).

4 Cut the $\frac{1}{4} \times 1 \times 16$ " pediment bottom molding (B). Rout all four edges with a $\frac{1}{8}$ " round-over bit. Flip the workpiece onto its other face and repeat the round-over cut to make a bullnose profile.

5 Glue the pediment bottom molding to the pediment. Make sure the molding overhangs the pediment evenly on all four edges.

6 Clamp this assembly upside-down in a vise. Mark the position of the $\frac{3}{8}$ " holes for the dowels that will join the pediment assembly to the upright (D) later. To mark the holes accurately, find the center of the pediment molding. Then, referring to the Upright End View detail, space the holes on both sides of center.

7 Clamp the assembly to your drill-press table's fence with the molding

parallel to the table and facing up. Drill the $\frac{3}{8}$ " holes $\frac{3}{4}$ " deep.

8 Cut the $\frac{3}{4} \times 1 \times 15\frac{1}{2}$ " base center (C). Mark and drill the two $\frac{3}{8}$ " holes completely through C, where shown on the Base drawing. These holes must be spaced precisely the same distance apart as the $\frac{3}{8}$ " holes in the pediment assembly A/B.

9 Clamp the pediment assembly upside-down in a vise. Cut four $\frac{3}{8}$ " dowels $1\frac{1}{16}$ " long. Tap two of those dowels (unglued) through the base center (C) until they protrude about $\frac{1}{2}$ " from the top face. Position C top-face-down on the A/B assembly, align the protruding dowels with the $\frac{3}{8}$ " holes in A/B, and dry-clamp.

10 Refer to the Exploded View drawing, and mark the $\frac{3}{32}$ " holes in pediment bottom molding (B), where shown, centered from edge-to-edge. Drill $\frac{3}{32}$ " holes through C and $\frac{1}{2}$ " into A/B. Make certain that you are holding the drill at a right angle to the assembly.

11 Cut the $\frac{3}{4} \times 2 \times 8\frac{3}{8}$ " upright (D). Mark and drill the $\frac{3}{8}$ " dowel holes $\frac{3}{4}$ " deep, where shown on the Upright End View detail.

12 Rout $\frac{1}{4}$ " chamfers along the two front edges of D where shown.

Now, trim the base

1 Cut a $\frac{3}{4} \times 2\frac{1}{4} \times 48$ " strip of molding for the base molding. Check the size of the base center (C), and miter-cut parts E and F to fit. Do not attach, yet.

2 Copy the base full-size half pattern found in the *WOOD PATTERNS* insert.

Adhere the pattern to stiff card stock and cut to shape with scissors. Trace the shape of the pattern onto the left side of E, then flop the pattern and trace it onto the right side. Repeat for the other part E.

3 Bandsaw the Es to shape. (We used a $\frac{1}{8}$ " blade.) Saw just the bottom edge—the profile on the top corners is routed later. Sand the sawn edge.

4 Glue and clamp the two E moldings to the base center (C). After the glue dries, glue and clamp the F moldings.

5 Rout the profiled top edges of the base assembly with a $\frac{3}{8}$ " beading bit. To avoid chip-out, back up the router cuts with a scrap piece, and make the cut in two passes. Before making the final pass, test it in scrap stock.

Assemble the stand

1 Cut two $\frac{1}{2} \times 1\frac{3}{8} \times 7\frac{3}{4}$ " pediment top moldings (G). Rout all four edges with a $\frac{1}{4}$ " cove bit, where shown on the Exploded View drawing.

2 Cut the $\frac{1}{4} \times 1 \times 1$ " finial base (H). Drill a $\frac{3}{8}$ " hole at its center.

3 To join the pediment, upright, and base assembly, lay the parts down on a scrap of flat plywood, in their assembled orientation. Clamp the base assembly to the plywood.

4 Assemble the upright and pediment to the base assembly with glued dowels that you cut earlier. Place $\frac{7}{8}$ " spacer blocks beneath the upright and the flat surface of the pediment, as

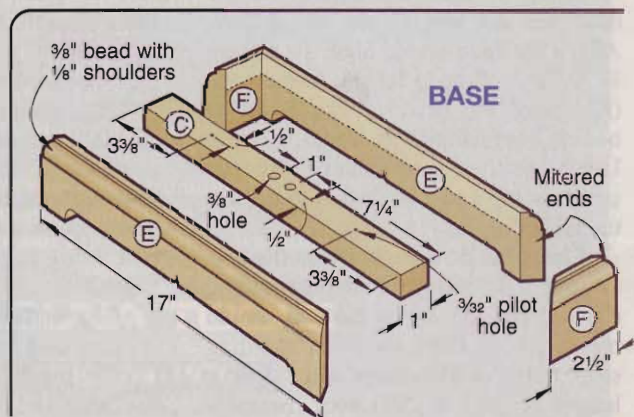

pivoting picture frames

shown in *Photo A*. Position a clamp from the center of the pediment to the center of the base. Check for square, tighten the clamp, and let dry.

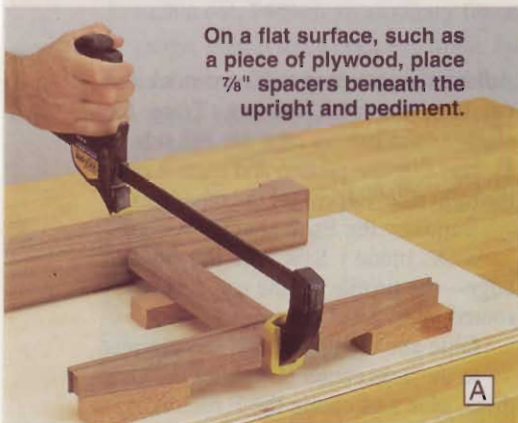

5 Apply glue to the tapered top edges of the pediment, and apply the G moldings. Check for equal overhang all around the molding, hold them in place with masking tape, and apply clamps.

Next up, the photo frames

1 Joint one edge of a 4'-long, 3/4"-thick board. Rip a 1"-wide frame-molding strip from the jointed edge.

2 Fit your router with a 1/8" round-over bit, and adjust it to cut a bead with a 1/16" shoulder, as shown in the Frame Section View detail. Rout this profile along one edge of the 4' strip.

3 Install a 1/4"-wide dado set in your tablesaw, and elevate it to cut 1/4" deep. Set the fence 1/4" away from the dado set. Then, with the beaded edge down and against the fence, cut the rabbet that will hold the glass/photo/card-board later.

4 Add an auxiliary wood fence to the tablesaw fence, and adjust it so the dado set just touches the wood face. Adjust the dado set 5/8" high. To make a 3/8" rabbet 1/4" deep for the frame back (K), place the beaded edge down as before, but facing away from the fence. Use a featherboard clamped to the tablesaw top and a pushstick to control the rabbeting cut.

5 Check the distance between the bottom of the pediment bottom molding (B) and the top of the base. It should measure 8 3/8". From the frame-molding strip, mitercut four frame stiles (I) to a length 1/8" shorter than your measure-

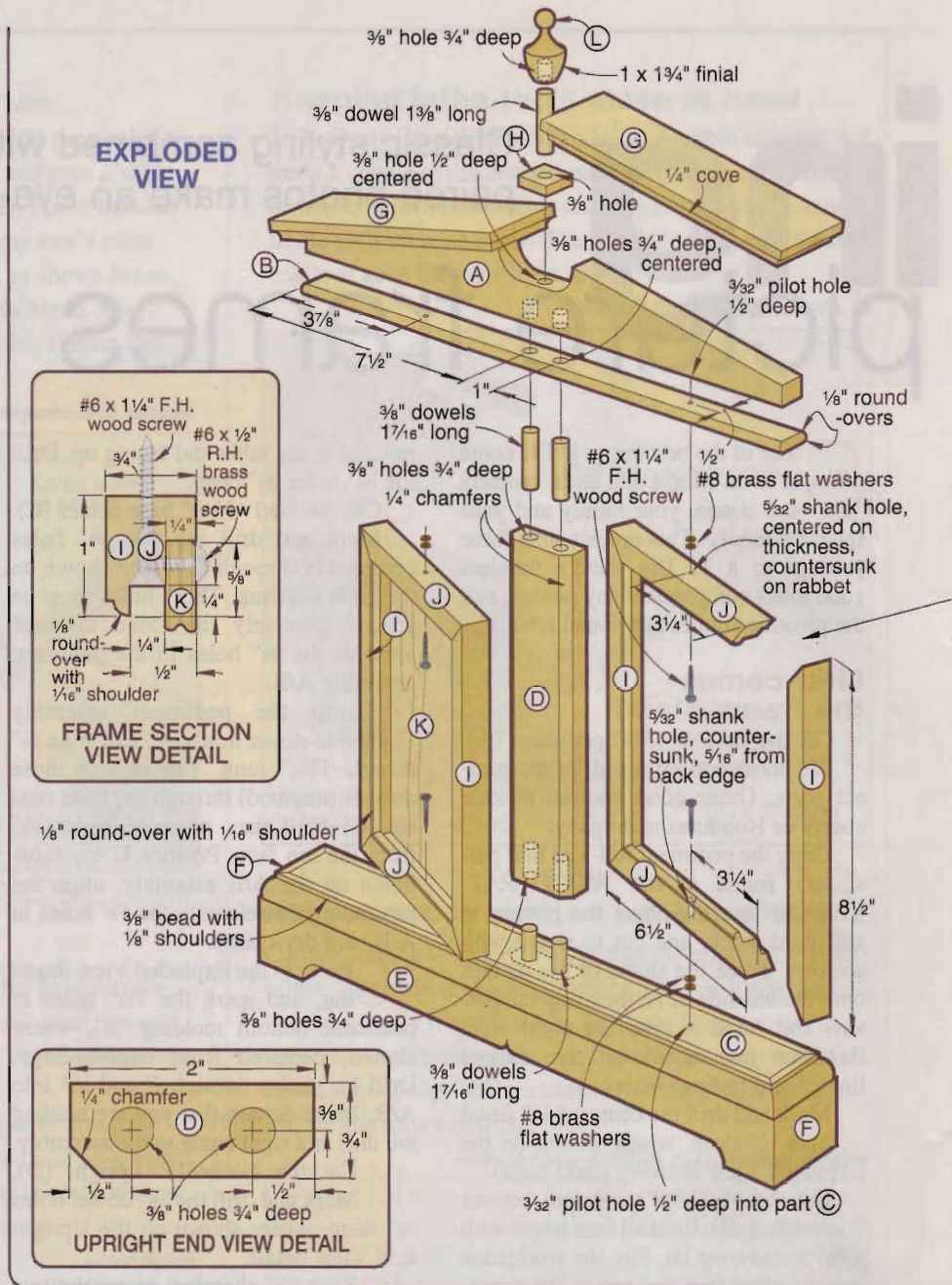

ment (8 1/2" ideally). For pieces of consistent length, use a stopblock clamped to an auxiliary miter-gauge fence.

6 Mitercut the frame rails (J) to 6 1/2" long, measured toe-to-toe.

7 Mark and drill the 5/32" shank holes centered on the frame rails, where shown on the Exploded View drawing. Countersink the hole on the rabbeted side, using a small countersink or a 1/4" twist drill.

8 Glue and clamp the frames together, checking for square.

9 Cut the 1/4"-walnut plywood frame backs (K) to match the openings in

the frames. Sand a 1/16" round-over along the edges.

10 Along the long edges of the backs, measure up and down from each corner 3/4", and make a mark. Then, measure in 3/16" from the long edge, and drill a 5/64" shank hole at that point for the #6 x 1/2" roundhead wood screws.

11 Position the backs in the frames. Use the 5/64" holes as a guide for drilling 3/32" pilot holes for the back screws.

12 To attach the frames to the stand, slide a #6 x 1 1/4" flathead wood screw into the shank hole in the top rail from the rabbet side. Slip two #8 brass

cutting diagram

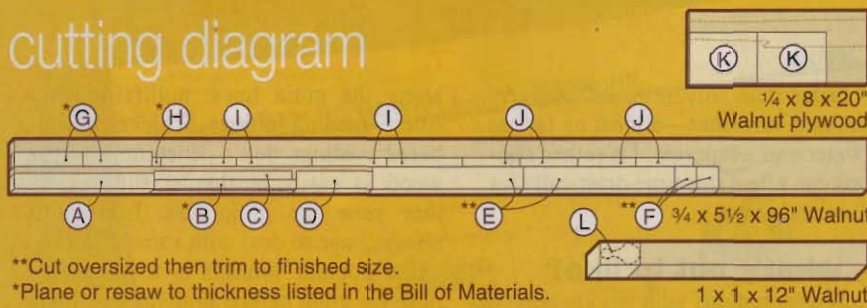

**Cut oversized then trim to finished size.
*Plane or resaw to thickness listed in the Bill of Materials.

bill of materials

pivoting picture frames

| Part | FINISHED SIZE | | | Mater. Qty. |
|----------------------------|---------------|--------|---------|-------------|
| | T | W | L | |
| A pediment | 3/4" | 1 3/4" | 15 3/4" | W 1 |
| B pediment bottom molding | 1/4" | 1" | 16" | W 1 |
| C base center | 3/4" | 1" | 15 1/2" | W 1 |
| D upright | 3/4" | 2" | 8 5/8" | W 1 |
| E* base front/back molding | 3/4" | 2 1/4" | 17" | W 2 |
| F* base end molding | 3/4" | 2 1/4" | 2 1/2" | W 2 |
| G pediment top molding | 1/2" | 1 5/8" | 7 3/4" | W 2 |
| H finial base | 1/4" | 1" | 1" | W 1 |
| I frame stiles | 3/4" | 1" | 8 1/2" | W 4 |
| J frame rails | 3/4" | 1" | 6 1/2" | W 4 |
| K frame backs | 1/4" | 5 3/4" | 7 3/4" | WP 2 |
| L* finial | 1" dia. | 1 3/4" | | W 1 |

*Cut parts marked with an * oversized. Trim to finished size according to the instructions.

Materials Key: W—walnut, WP—walnut plywood.

Supplies: 3/8" dowel, 1 1/16" long (4); 3/8" dowel, 3 1/2" long; #6x1 1/4" flathead wood screws (4); #8 brass flat washers (number varies); #6x1/2" roundhead brass wood screws (8); single-strength glass approximately 5x7" (2); Minwax Special Walnut Wood Finish (stain); clear finish.

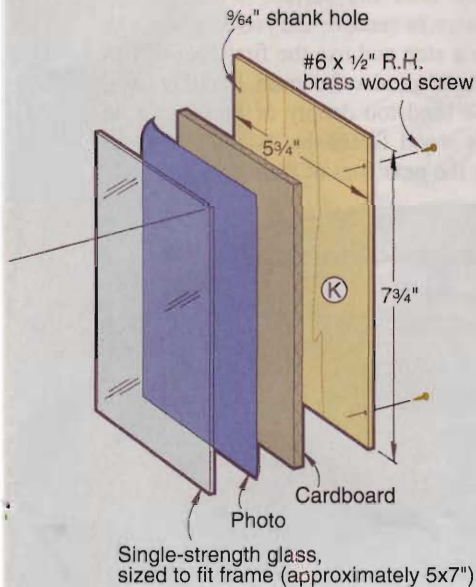

cutting into the marked circle. Chamfer the four edges.

4 Trim the finial blank to 1 3/4" long, measured from the end with the marked circle.

5 Secure this block in a wooden hand screw clamp, and on your drill press bore a 3/8" hole 3/4" deep at the awl indent. Glue a 3 1/2" length of 3/8" dowel into the hole and let dry. Chuck the dowel end of this assembly into your drill press.

6 Make a copy of the finial full-size pattern shown in the *WOOD PAT-TERNS*® insert. Adhere the pattern to stiff card stock, and trim the profile to shape with scissors.

7 To "turn" the finial to shape, use a flat rasp, a half-round rasp (also called a shoe rasp), and a 3/8" dowel wrapped with sandpaper. Set the drill press for a medium speed. Shape the finial, as shown in *Photo B*, leaving no facets from the chamfers.

8 Transfer pencil lines that correspond to the narrowest and widest diameters of the finial from the pattern to the block. Shape the finial, stopping frequently to tighten the chuck and compare your results to the pattern.

9 When you near the finished profile, use a succession of 80-, 100-, 150-, and 180-grit abrasives to achieve the final shape and smoothness. Remove

the finial from the chuck, and trim the exposed dowel to 5/8" long.

10 Apply glue to the dowel, and slide the finial base (H) onto the dowel and against the bottom of the finial. Glue the dowel into the 3/8" hole in the top of the pediment (A).

11 Disassemble the frames from the stand and finish as desired. We applied a coat of Minwax Special Walnut Wood Finish to stain the walnut to an even color. After that dried, we applied two coats of Olympic Interior Antique Oil Finish, buffing with #0000 steel wool between coats.

12 Reassemble the frames and stand, and have your glass supplier cut two panes of single-strength glass to fit the frames. Before placing the glass into the frames, cover the heads of the #6x1 1/4" flathead wood screws with small strips of masking tape to prevent the glass from chipping.

13 Assemble the frame contents, as shown on the Exploded View drawing. In the photo on page 82, we left out the cardboard and instead placed a double mat between the photos and the glass.

flat washers onto the shank and align the screw point with the 3/32" pilot hole in the bottom of the pediment bottom molding (B). Drive the screw to lightly snug up the washers. Repeat for the bottom rail.

13 Check for even spacing between the frames and base and the frames and pediment bottom molding. Add #8 brass flat washers if necessary.

And now, a finial finale

1 To make the finial (L), cut a 1x1x12" blank. If you don't have 1" material, laminate two thinner pieces and resaw or plane to thickness.

2 Trim the ends of the blank square. Draw intersecting diagonal lines on the end of the strip to find center, and indent with an awl. Use a compass to mark a 1"-diameter circle on the end.

3 Set up your router table with a chamfer bit with a 45° cutting edge. Raise the bit just high enough to chamfer the long edges of the blank without

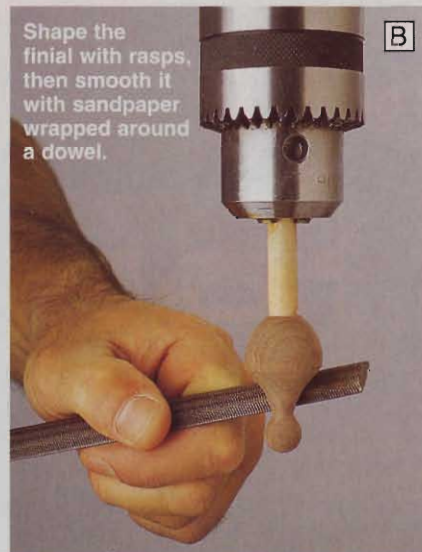

Shape the finial with rasps, then smooth it with sandpaper wrapped around a dowel.

Bring up the subject of water-based finishes with a group of woodworkers and they'll part like the Red Sea. Some woodworkers swear by them, while others swear at them. So what's the real deal on these products? To find out, we rounded up every water-based clear coating we could find, and put them to the test.

These finishes have a lot going for them

If it weren't for a heightened awareness of air-pollution issues in the 1970s, we might not be talking about this subject at all. Until that time, most clear finishes were (as many still are today) suspended in solvent, which evaporates into the air as the finish cures. Besides the health problems caused by inhaling large quantities of these airborne solvents, the fumes are highly flammable and contribute to air pollution.

Water-based finishes, though, contain only a tiny amount of solvent—just enough to bind the near-microscopic beads of resin together. That means the risk of damage to life and lung is lower. It also means that brushes and sprayers clean up easily with a thorough soap-and-water rinse. And, these finishes generally

cure faster than solvent-based polyurethanes and varnishes—almost as fast as the water can evaporate. (Weather conditions can effect this time drastically, as we'll explain later.)

So, what's not to like?

In our conversations with woodworkers, we hear two chief complaints about water-based finishes: grain-raising and color—or more accurately, the *absence* of color. Both have different causes and cures, but in a moment we'll offer one solution that answers both objections.

As you know, any time you expose unfinished wood to water, the wood fibers swell as they absorb the moisture. Even after the wood dries, some swelling remains. Because these finishes are mostly water, they raise ridges

along the grain lines, nullifying your finest sanding efforts. Thicker water-based coatings don't penetrate into the wood as easily as thinner finishes, so they raise the grain less. But you'll always have to deal with some swelling.

One popular solution is to purposely raise the grain before applying the finish by wiping the workpiece with a wet cloth. After letting it dry thoroughly, gently sand the surface with fine-grit abrasive to remove the raised grain. Or, save a step and use the first coat of finish itself to raise the grain. In either case, don't sand too deeply or you'll expose fresh wood fibers that will swell again with the next coat of finish.

We test low-tox
clear coatings
to help you get
the best

finish
out of
water



As for color concerns, solvent-based finishes give the wood—especially darker species—a warmth that water-based coatings, by and large, don't. In fact, of the sixteen finishes in our sample, only J.E. Moser Marine Spar Varnish (sold by Woodworker's Supply, 800/645-9292) assigned color to the wood reminiscent of a solvent-based finish. (See *top right* photos for a comparison.)

Most of the coatings we tested seemed to flatten and wash out the color in darker species of wood. To get the full richness of these woods, try staining your project before applying the clear coating, or add tint, such as Sheffield's Tints-All (also from Woodworker's Supply), to the finish before applying it to your workpiece.

When we use a water-based clear finish here in the *WOOD*® magazine shop, we address both the grain-raising and color issues in one step. After sanding the workpiece, we apply a solvent-based finish or sealer to impart color, "deepen" the wood grain, and seal the pores. After scuffing with sandpaper to reduce the little bit of grain raised, we topcoat with water-based finish, sanding lightly between each coat.

While we're on the subject of sanding, never use steel wool to abrade or de-nib a water-based coating. No matter how thoroughly you clean, some steel particles will remain and react with the water in the finish to form dark spots on your project.

More tips on the water front

•**Weather or not?** In ideal conditions, water-based finishes dry faster than solvent-based varnishes and polyurethanes, reducing the amount of dust nibs that settle in the finish. However they're also more weather-sensitive. In humid climes, the ambient air can't absorb the water as quickly, slowing the drying process. And high temperatures or low humidities cause

the finish to dry too rapidly before it can properly level out, resulting in pronounced brush marks or orange-peel in a sprayed finish.

To avoid such problems, pay close attention to the temperature and humidity requirements on the product label. If you must work in muggy conditions, try using a fan to draw a gentle flow of air over the finish as it dries. Be careful, though, not to stir up workshop dust that can also mar your work.

•**Chinks in the armor.** The water-based finishes we sampled all stood tall against abrasion, as their reputation for durability attests. Just make sure you let the coating cure completely. After letting the test samples cure for two weeks, a drop of water left on the surface for 10 minutes penetrated right down to the wood through many of the finishes. After curing for more than a month, though, those same finishes withstood the water for more than an hour.

However, we found a wide range of resistance to stain penetration among our sixteen sample products, as you can see in the photos at *right*. To test stain resistance, we applied a drop of barn-red water-based stain on top of each cured finish, let it stand for 30 seconds, then wiped it away.

Half of the finishes (Aqua Zar Gloss and Satin Polyurethanes; Behlen Water-reducible Lacquer; J.E. Moser Exterior Polyurethane, Marine Spar, and Cool Lac; Olympic Polyurethane; and Varathane Diamond Gloss) wiped clean, leaving no trace of the stain. Four others (Parks Pro Finisher; Valspar Gloss and Satin Polyurethanes; and Minwax Polycrylic) allowed some stain to remain. The rest stained deeply.

Be selective when choosing which projects to finish with water-based coatings. Depending on the project, spills and stains may not be a big concern, but if they are, such as on a coffee-table top, we suggest buying a small container of finish and first testing its stain resistance on a piece of scrap before applying it to your work.

•**Application methods.** You can brush or spray water-based finishes the same way you'd apply a solvent-based product. Apply thin coats to reduce sagging and running. To reduce bubbling, we like to use a high-quality synthetic-bristle brush with very fine bristles and fine flagging.

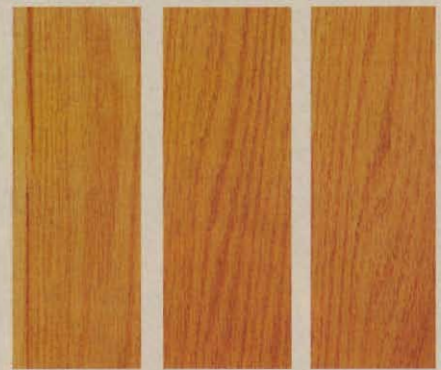

The difference appears subtle, but the *left* board shows an oak board coated with a typical water-based clear finish; the *middle* board shows the color imparted by J.E. Moser Marine Spar Varnish. The board on the *right* was sealed first with a solvent-based finish, then top-coated with a clear water-based finish. Notice the warmer red tones in the two boards on the *right*.



Aqua Zar Polyurethane (*left*) repelled our water-based stain completely, while Valspar Polyurethane (*center*) allowed some staining. General Finishes Polycrylic (*right*) stained deeply.

Soaking the brush in water before using it to apply the finish breaks the surface tension and further reduces bubbles. If you like to use disposable brushes, opt for the denser, less-porous foam, and you'll get fewer bubbles in the finish as you brush.

Finally, when spraying, make sure you wear a filtered mask. While it's true that the floating fumes are less hazardous than solvent-based products, the atomized droplets of finish can still harm your lungs if inhaled. Thoroughly rinse your sprayer immediately when you're done, then spray a little lacquer thinner through it to prevent corrosion and remove any cured finish. 🌿

Written by Dave Campbell with Dave Henderson
Photographs: Baldwin Photography

desert dustbin



Here's a design
that turns a
mundane
household
object into an
accessory with
personality.

bill of materials

southwestern wastebasket

| Part | FINISHED SIZE | | | Mater. Qty. |
|----------|---------------|---------|---------|-------------|
| | T | W | L | |
| A sides | 1/4" | 10 3/8" | 11 3/4" | BP 4 |
| B bottom | 1/4" | 7 7/8" | 7 7/8" | BP 1 |
| C cleats | 1/4" | 3/8" | 5 1/2" | BP 4 |

Material Key: BP-Baltic birch plywood.

Supplies: 1/2x36" dowel, finish, leather lacing (4 pieces, 30" long).

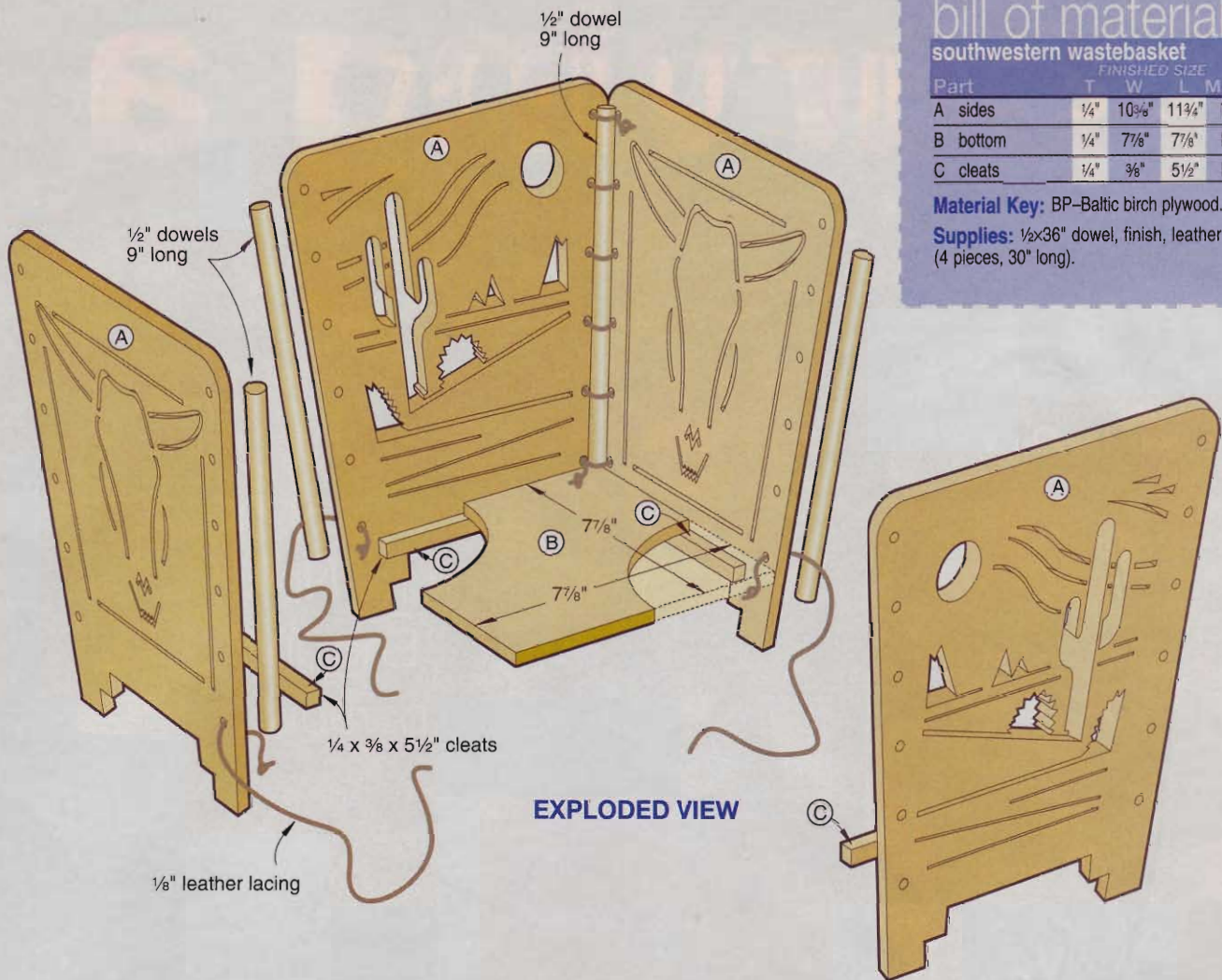

Stack-cut sides and the simple lace-up corners make this a fine weekend project. It's a perfect excuse to get your young cowhand into the shop.

Forming the parts is quick and easy

1 From 1/4" Baltic birch plywood, cut the side blanks (A), bottom (B), and cleats (C) to the sizes listed in the Bill of Materials. Set the bottom and cleats aside.

2 Stick the side blanks together in pairs with double-faced tape. Make copies of the side patterns from the *WOOD PATTERNS*® insert, and adhere them to the paired side blanks. Drill starting holes for the inside scrollsaw cuts and 1/4" holes for the lacing.

3 Scrollsaw the patterns, using a no. 5 or no. 7 blade. Separate the paired sides, and remove the patterns. Finish sand to 220 grit, and glue the cleats (C) in place, where shown on the pattern. Scrollsaw a 1/2x36" dowel into four 9" lengths.

4 Finish all parts with two coats of polyurethane, sanding lightly with 220-grit sandpaper between coats.

Lasso the corners with leather lacing

1 Temporarily hold the sides together with masking tape, as shown in

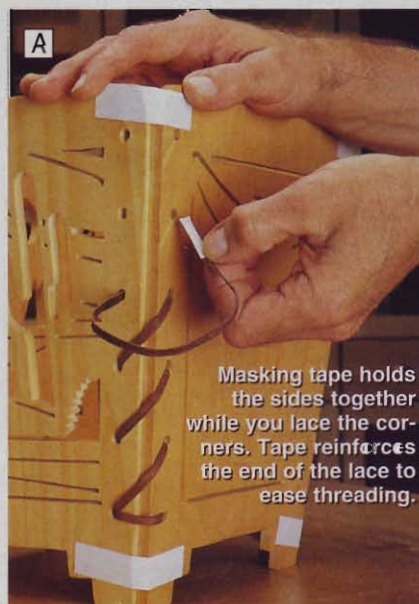
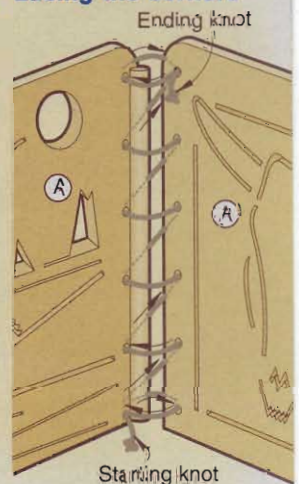

Photo A, in the configuration shown on the Exploded View drawing. Drop the bottom (B) into place.

2 Position the dowels, in turn, in each corner, with their ends tight to the bottom, holding it in. Bind the dowels in place with 30" lengths of leather lacing, as shown in *Drawing 1*. We bought our lacing at a craft supply store. Leather shoelaces will work, too. Trim the excess lace after tying the knots.

DRAWING 1 Lacing the corners



Written by Jani Hale Svec with Charles L. Hedlund
Design: David Ashie
Illustrations: Roxanne LeMoine; Lorna Johnson
Photographs: Baldwin Photography;
BalfourWalker.com

carving a niche

Tom Golding
chips away in
a rural New
England
paradise



in Vermont

Near the idyllic Vermont village of Saxtons River, 52-year-old Tom Golding creates uniquely designed pieces of fine furniture, decorative accessories, and architectural elements, all adorned with intricate carving. Tom's rare combination of talents as a woodworker and a woodcarver enable him to completely control the design, construction, and embellishment of everything that he makes. "When I design a piece, the woodcarver in me knows what the woodworker is doing and vice versa," says the silver-haired craftsman. And it's this compatible control that results in distinctively attractive work that's admired, purchased, and proudly displayed by his customers.

Carving takes practice while designs just happen

Tom built upon the woodworking skills he learned as a young adult (see the sidebar, *right*) by observation, self-study, and hands-on application. Carving came to him by somewhat the same route.

"Except for a two-week session in Colorado with classical carver Nora Hall, I learned it by looking at other types of carving and reading books," Tom comments. "I began with chip carving, referring to Wayne Barton's books. He's a master chip carver. I also studied books that were inspirational with their patterns and designs. I would think to myself that they were beyond me, but I'd go ahead and try

to figure out how they were done. And I discovered that I actually could develop the technique to do them."

The artistic side of carving—the designing—just happened. "A lot of it follows the principle that comes naturally to me—going from the general to the specific," he says. "I get a general idea for the pattern first. Then I go to the specific—the details. But I think that's pretty typical with any type of art."

Although Tom has been called a "classic" style carver, using ancient Greek and

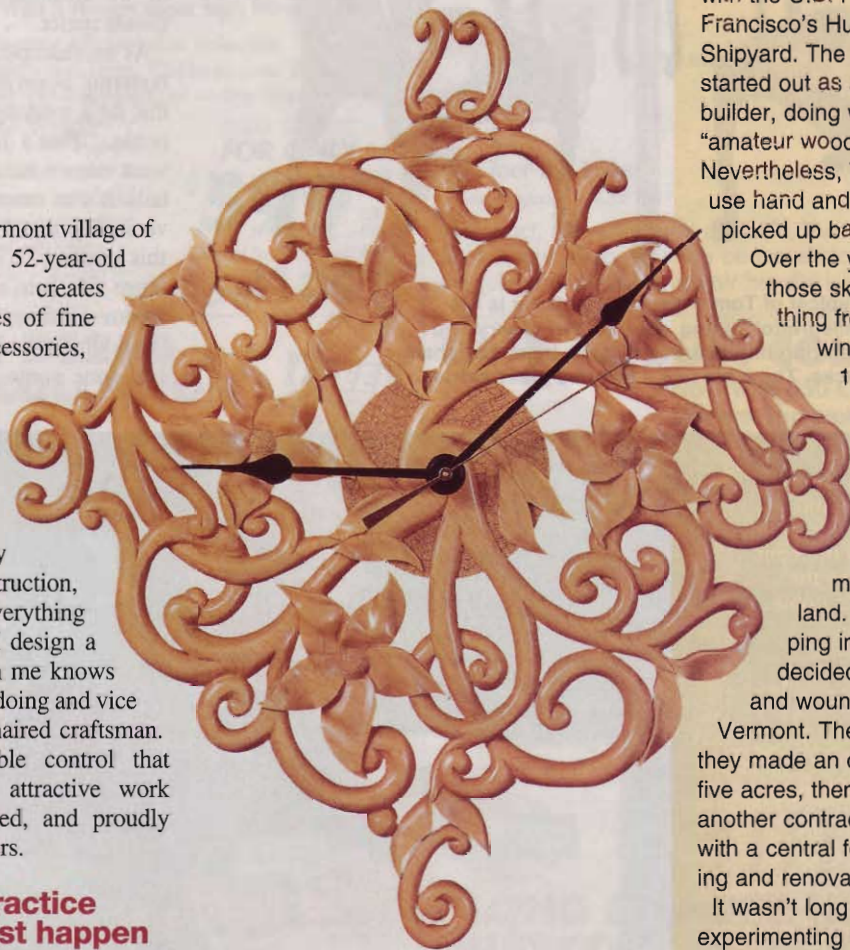

A winding road to carving

In 1965, at age 18, Tom Golding unsuspectingly began a woodworking career when he got a civil service job with the U.S. Navy at San Francisco's Hunter's Point Naval Shipyard. The young Californian started out as an apprentice boat builder, doing what he refers to as "amateur woodworking."

Nevertheless, Tom did learn how to use hand and power tools, and picked up basic woodworking skills.

Over the years, Tom expanded those skills by building everything from houseboats to

windmills. By the early

1980s, he and his wife

Diane had estab-

lished a small con-

struction business in Southern California.

By 1982 the couple had put away enough

money to buy some

land. But instead of shop-

ping in California, they

decided on New England,

and wound up in Brattleboro,

Vermont. The day after arriving,

they made an offer on a house with

five acres, then set out to build

another contracting business—one

with a central focus on general building and renovation.

It wasn't long before Tom began experimenting with adding carvings to architectural pieces, such as beams, doors, and posts, as well as making carved mirrors and clocks. "When I started adding the carving, the work really became enjoyable, and I looked forward to more," he recalls.

Eventually, after a move to rural Saxtons River, he was able to phase out the construction business and focus on furnituremaking and carving. He and Diane also began raising and selling Icelandic sheep. "The sheep make good pets, wool, and manure, and are good for mowing, so they're my best friends," he jokes.

carving a niche



Typical of Tom's elegant creations is his "Allegetto" dining set, made of cherry and featuring hand-carved filigree, legs, and chair backs. The table has a beveled glass center.

Roman themes, he'll work in many styles. His preference, though, is Art Nouveau, a design theme of the late 19th century characterized by sinuous lines and floral motifs. "I've tried a lot of styles—classical, folk, East Indian, Hindu, Celtic, you name it," he states. "But Art Nouveau is the style I choose if I design something that I want to make for the sake of doing it. Making a living as a carver, though, I need to be flexible, creating whatever my clients prefer."

As an example, he points to the carved butternut beam shown in the photo *below* that he's working on for a local logger's home. "That's for a log cabin, so they want nature scenes with ducks and cattails. It's an example of the flexibility and versatility that I need to demonstrate in this business." (For an even greater challenge for Tom's skill, see "Crafting the rosette window," *opposite page*.)

In addition to his own designs, the carver has done some reproduction work with



At his workbench, Tom continues to refine the carved details on this nearly 200-pound butternut beam that will soon grace the ceiling of a client's home.

great success, but it'll never be his first choice. "I once reproduced a chair to the point where nobody could tell which was the original. When I reproduced yet another one, I couldn't even tell," he chuckles.

From doors to dining sets, the work keeps coming in

Since Tom opened his shop near Saxtons River, his business has grown continually. Besides selling noncommissioned pieces, commissioned work keeps increasing. One such commission was for two 8'-tall, 3"-thick, carved mahogany doors that were installed in a union hall. Another, yet to be done, is a 18"×30' wall art panel featuring a unicorn figure and a female figure to symbolize purity.

"I intend to make it from book-matched, 4"-thick, walnut panels left over from a 4"×20"×8'-long piece that I've used for some other projects in the past," he says. "I initially paid around \$300 for that chunk of walnut, but I estimate that when it's gone, the wood will have been used in about \$35,000 worth of work."

That the stock used represents only about 10 percent of the selling price of his work surprises some people. But carving is labor-intensive. For the carving-enhanced cherry dining room set, shown *opposite top*, Tom got \$19,000. "That may seem high," Tom says of the project, "but it reflects the several months it took to produce. However, my pieces commonly have prices as varying as their designs. There's the high-end and the low-end, and lots in the middle. My Celtic-motif hand mirror, for instance, brings a reasonable \$125."

Tom is very comfortable with his pricing. "When I arrive at a price for a piece, it's because I simply couldn't do it for less and remain in business," he says frankly. "Pricing is difficult in the beginning. You're always bashful about asking too much. But you gain confidence, and learn to put a price on something that truly stands for the actual work that you put into the piece."

Much of Tom's business is repeat. But surprisingly for his rural location, he gets drop-ins, too. He calls them "spontaneous buyers," who just happen upon his shop while driving in the beautiful, tranquil countryside. "I've had people walk in, look around, then simply spend several thousand dollars for a couple of pieces of wall art," he recalls.

Crafting the rosette window

Perhaps the most ambitious project Tom has ever launched is one for himself. It's a 6'-diameter carved rosette inlaid with stained glass and surrounded with a mantel ring of intricate carving. The huge piece eventually will hang in the second-story window of the gallery.

"I made the rosette from 25 1½"-thick pieces of basswood," Tom notes. "It has 30 joints that are doweled or splined as necessary. The openings for the glass I cut out with an orbital jigsaw. I've enjoyed my four months of work on it because of the challenges, both technical and aesthetic," he says. "And all told, I believe it's worth \$20,000."



With a rabbeting bit, Tom routs the back of the rosette's center to accept the first piece of stained glass, *below left*. Tom continues to rough-carve the design on the rosette's mantel ring, *below*, with gouges. *Bottom*, glassmaker Rick Neuman helped Tom insert the center glass, then hold the rosette in place against the window. It's finished with marine oil.

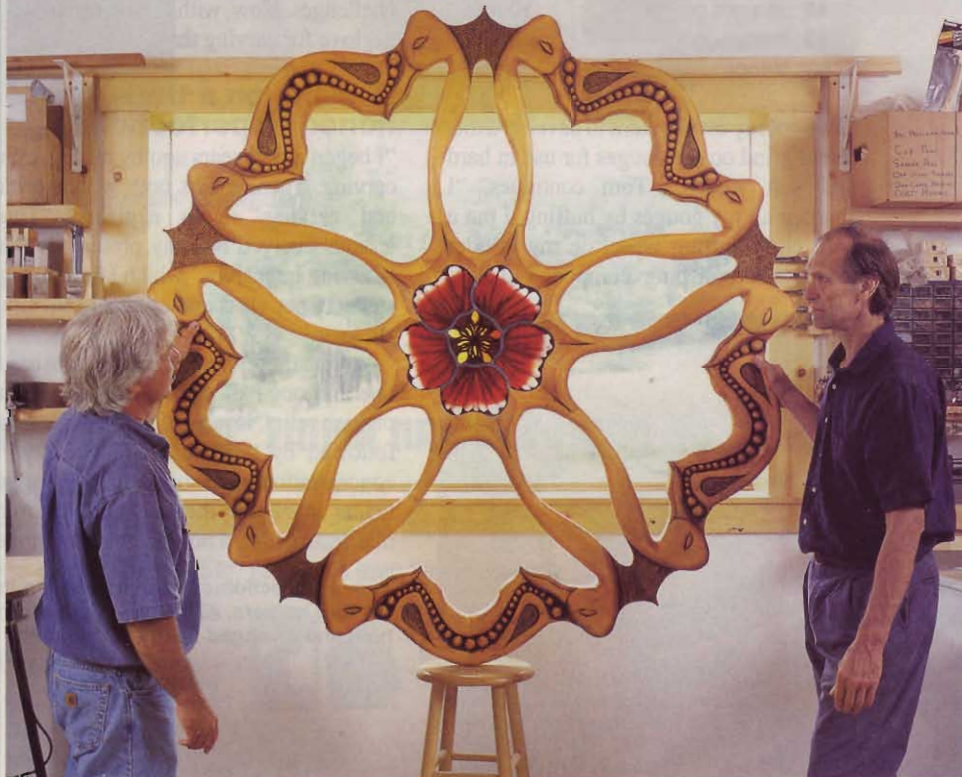

carving a niche

Carving uses hand tools; furniture needs power

Tom is a perfectionist. His furniture and carvings give every indication of that, and so does his shop. It's neat. It's organized, as evidenced *below*. Everything has its place. But there's creativity in the most subtle of places. There are, for instance, hand-carved, paddle-like extensions from his stationary machinery's power switches. They're not only aesthetically pleasing but technically functional.

Although Tom employs only hand tools in his carving, the craftsman admits his liking for the power tools so evident everywhere—a 6" jointer, a 20" planer, a 10" Powermatic tablesaw, a 20" bandsaw, a 20" drill press, a few scrollsaws, and a shaper. "They represent accuracy and speed," he says. And they allow him to spend more time with the knife and carving gouge.

But like many woodworkers, Tom knows that he has too many tools. "All I need for carving is about a dozen tools," he admits. "In fact, I start off my students with the Golding Carving Tool Set." Here's what's in it:

The Golding Carving Tool Set all you need to start carving

| | |
|--------------------|-------------|
| #5 straight gouges | 3 & 12 mil. |
| #11 straight gouge | 3 mil. |
| #3 straight gouge | 12 mil. |
| #7 straight gouge | 10 mil. |
| #8 straight gouge | 10 mil. |
| #3 fishtail gouge | 8 mil. |
| 60° V-tool | 8 mil. |

"I've got my own system to develop a different grind on the gouges for use in hard and soft woods," Tom continues. "I sharpen all my gouges by buffing. I put a hard cloth buffing wheel on my grinder and use a polishing compound that is



After only a few minutes of instruction, 10-year-old student Victoria Duvall puts a gouge to work doing relief carving on a Celtic design in basswood.

intended for use on stainless steel (SCR made by DICO). It doesn't clog the buffing wheel as readily as would a more aggressive compound, such as emory. Because I carve mostly softer woods, such as basswood and butternut, I normally use a shallow bevel angle. But when I carve a harder wood, like cherry, the cutting edge dulls quickly unless I steepen the angle of the gouge bevel. And I do that with the buffing wheel. Believe me, I keep the buffing wheel real close when I work with the hardwoods!"

And it's that time-consuming handwork that he's mastered that drives him to new challenges. Now, with fervor, he passes on his love for carving through teaching.

Passing on a tradition honed to perfection

"I began a few years ago by teaching chip carving. Then, it was both woodworking and carving," Tom explains. "Those lessons evolved into my present five-day 'Carving Intensives,' which I limit to eight students per class and conduct four times per year."

A typical carving workshop consists of one and one-half days of formal training on high relief, low relief, and chip carving, followed by three and one-half days of concentration in one of those styles of particular interest to the student. With minimal instruction, Tom has the participants

Tom's perfectionism is evident even in his tool holders. All carving gouges are held and arranged neatly in this unit.

carving very quickly. "When people come, they're carving within the first 10 minutes," he comments. "I show everyone in the morning, 'This is how you hold the knife. This is how you hold the chisel.' Once they know how to use them, that's that. The rest of the time I'm showing them how to make their work look good."

Carving Intensives workshops currently cost \$390, including materials and tools. To date, they've attracted students of all ages from as far away as Hawaii.

From all appearances, fate has been good to Tom. He lives in the picturesque Vermont countryside working at what he enjoys. The road there may have had some detours, but Tom won't hesitate to tell you that it has all been fun. "So far, I'd call it a fulfilling journey," he says, almost with a sigh. "Often, not knowing exactly what lies ahead means pleasant surprises." 🌿

Written by Owen Duvall with Peter J. Stephano
Photographs: Randy O'Rourke

Carving and more carving

For a brochure describing Tom's work and/or to find out about his carving classes, send a self-addressed, stamped, business-size envelope to Fine Art Woodcarving, HCR 33, Box 7, Saxtons River, VT 05154. View Tom's carvings on his website. Go to www.sover.net/~carving. Call 800/710-1872

Answers to woodworking questions gathered from your letters and e-mails, and our WOOD ONLINE® discussion groups.

Bugged by old barn boards

Q Can you give me information on salvaging and re-milling old barn lumber for various woodworking projects? Specifically, is it OK to use lumber that has visible insect damage? What precautions should I take when milling and storing this wood?

—Brian Florin, via internet

A Old barn lumber appeals to woodworkers because of its low cost, rustic appearance, or the sheer mass of the old beams. However, it does not come without drawbacks, the most obvious being insect damage. Before you bring it inside and risk infesting your other stock, check with your local exterminators. One of them may have a fumigation chamber and can fog your lumber with an insecticide. If you live close to a sawmill, you might contract for their kiln. A temperature of 130° Fahrenheit will take care of any bugs, and dried to a 12 percent moisture content, wood won't sustain insect life. In an arid climate, you can dry the wood yourself, making sure that air circulates freely between the boards.

If none of these options work, examine the wood carefully and use your best judgment. Discard any material that appears actively infested. Store it in the same way you store your other stock. Stack and sticker it, making sure that air circulates freely so the wood stays dry.

However, some problems are not so obvious as insects. Nails and wire hid-

den below the surface can ruin your planer, jointer, or saw blades. So be sure to check the lumber thoroughly using a metal sensor. Zircon (800/245-9265) makes one called MetalliScanner 6.0 that scans to a depth of 6" through solid concrete (about \$120).

You also need to be mindful of the hazards of lead-based paint. Your old barn lumber was probably painted with it, and you need to avoid breathing or ingesting the toxic dust kicked up when milling. So wear a respirator. A "brake and clutch respirator," available at your local auto parts store, is designed for technicians who work around asbestos. It will trap the lead particles in the dust. Plane your barn boards all at once, let the dust settle, vacuum, and wash up.

We're told by our state health department that homeowners in our area can dispose of the dust at curbside with their weekly refuse pick-up. The regulations vary, however, so contact your state health officials to see if they have more restrictive rules.

Fighting the warp factor

Q Even though the weather was cold and rainy, I needed to finish a solid pine tabletop for delivery. I warmed up my spraying equipment and shot the underside with three coats of nitrocellulose lacquer. I ended up with some severe

blush, so I waited for better weather before shooting the top surface. After three more days of rain, the tabletop bowed severely. Any tips on getting out of this predicament?

—Rad Hall, Sausalito, Calif.

A The problem, of course, is that moisture absorbed into the top, but not the bottom. Often it will warp back flat when the moisture re-equalizes. I suggest you put a heat light or two on it or have a small heater blow warm air over it for a few days. If this works, you won't have built up stress from trying to force it flat.

—Rod Cole, Lexington, Mass.

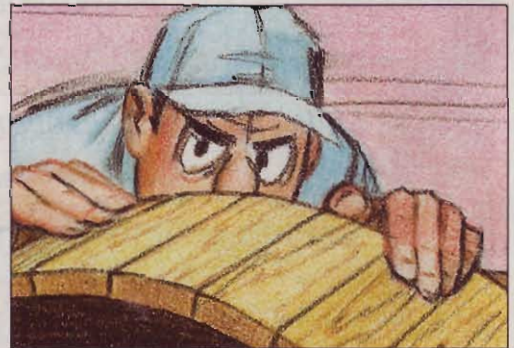
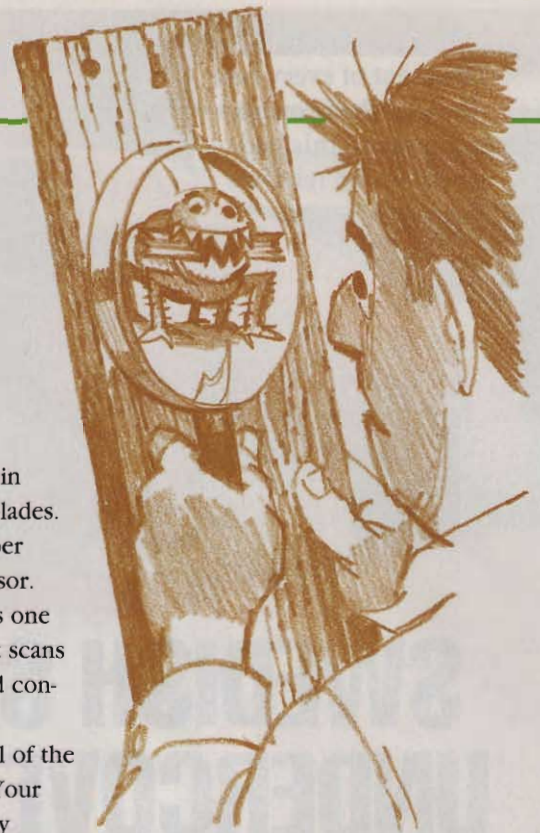

Continued on page 98

How to give outdoor projects extra life

Q I make outdoor cutouts and whirligigs with five-ply plywood, and finish them with acrylic paint. But the weather ruins them in a short time. What should I use for a primer and finish coat?

—William Webster, Parsons, Tenn.

A First, Bill, make sure you're using exterior-grade plywood, which is bonded with waterproof glue. When your project is ready for painting, start with an oil- or alkyd-based primer and cover all the surfaces, not just the ones that will show. Sand that coat lightly with 180-grit sandpaper to improve the adhesion of the top coats. Then, apply two coats of the very best exterior-grade, oil-based enamel you can find. That will stand up to the elements better than acrylic paint, which is water-based. But you're not done yet. Wax the piece with a furniture-style paste wax. Clean it once a year with ammonia and water, and re-apply a coat of wax. The wax protects the paint, the paint protects the wood, and the piece will look sharp for a long time.



How about cypress?

Q As a volunteer at a nearby nature center, I want to make a pamphlet box that will sit outdoors. Would cypress be a good choice for this project? How does it rate for machining, gluing, and staining?

—Charles Petrowski, Marriottsville, Md.

A How time flies. Chuck, it was way, way back in *WOOD* magazine issue 20 when we wrote about the fine qualities of cypress. This wood—also known as bald cypress, black cypress, and swamp cypress, among its many nicknames—resists decay and stands up very well in outdoor projects. It works easily, glues well despite its resinous feel, and holds finishes with no problems. In other words, you've made an excellent choice.

—WOOD Magazine

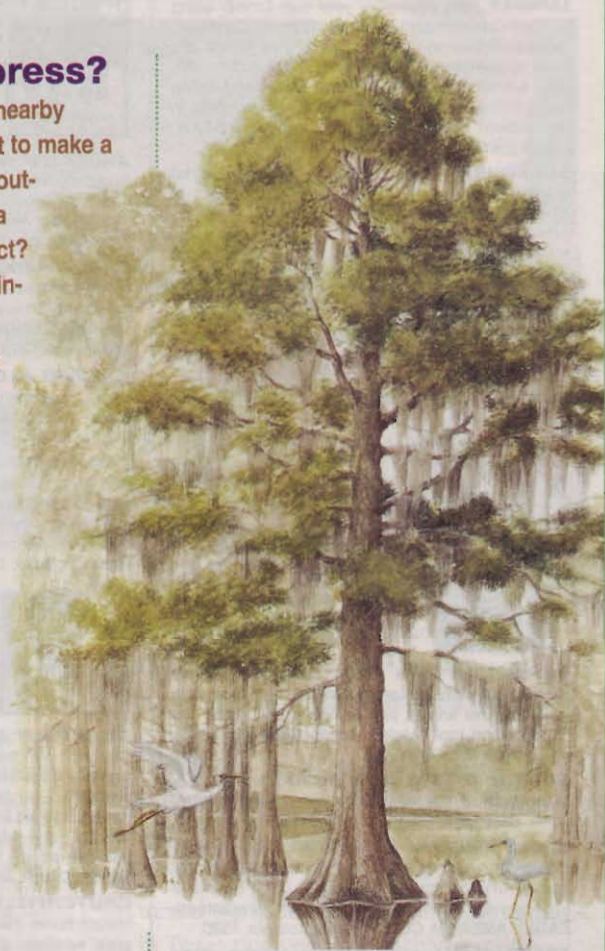

I like the pocket reference available from most of the mail-order catalogs. It has most geometry formulas that a woodworker needs, as well as trig formulas and tables. It also lists the weight and strength of most common woods.

—WOOD ONLINE participant

Where can I find math help?

Q Can anyone recommend a math/geometry book that's useful in the woodshop? I'm decent at mathematics, but who can remember all the equations? It would be great to find a reference book that caters to the woodworker.

—Darren Thomas, Auburn, Wash.

A I use mathematical tables from the Handbook of Chemistry and Physics. I keep it by my slide rule.

—Bill Wiles

I use a machinist's handbook. It includes all of the equations, tables, and so forth that I will ever need.

—Mike Moffet

Got a question?

If you're looking for an answer to a woodworking question, write to: **WOOD Forum, 1716 Locust St., GA 310, Des Moines, IA 50309-3023.** For an immediate answer to your question, get help from fellow woodworkers by posting it on one of our Internet discussion groups at: www.woodomine.com.

Inflatable roof rack stows small, works big

If you've ever stumbled onto a load of bargain lumber at an auction and said to yourself, "Gee, I wish I'd brought the truck," you need to stash a HandiRack inflatable roof rack in the trunk of your car. This temporary apparatus cushions the roof from damage and distributes the load's weight.

The HandiRack consists of a pair of nylon-reinforced bladders, each with a long nylon strap on one end. And, securing them to your vehicle is simple. First, position one bladder on the roof and thread the strap through the passenger compartment. Cinch the strap through the cam lock on the other end of the bladder, and close the doors. Then repeat the process for the second bladder. On a mini-van, you can use the rear windows or vents.

I found I didn't have to really wrench the strap to get it tight because any slack was taken up when I inflated the bladder. The HandiRack's air pump works both ways, adding air on both the push and pull stroke. It took me about 20 seconds to fill each bladder.

For securing your load, each bladder has five D-rings, located about every 9" along its length. The outermost rings aren't wide enough to straddle 48"-wide sheetgoods, but I tied on a panel anyway. Even at highway speeds, the 1/2" sheet didn't so much as flutter in the wind.

You can carry loads up to 180 pounds on the HandiRack. With dense loads of stock, I worried that I might

get some load shifting when accelerating and braking, but the HandiRack absorbed that force without letting the load slip. After you unload, deflate the bladders (only a little unhandy, thanks to the check-valves), roll them up, and slip them and the pump into their shoe-box-size carrying case.

—Tested by Dave Henderson



PRODUCT SCORECARD

HandiRack

| | |
|-------------|-------|
| Performance | ★★★★☆ |
| Price | \$60 |
| Value | ★★★★☆ |

Call Delcor Industries at 303/979-7175, or visit www.roofracks.net.

Maker of Quick-Grip clamps gives you the Advantage

When American Tool Company first introduced the Quick-Grip bar clamp several years ago, its one-handed action stood the clamping world on its ear. Although handy for lots of shop chores, I found that the clamps couldn't

provide the same pressure as threaded bar or pipe clamps.

The Quick-Grip Advantage clamp, with its threaded jaw (shown in the photo at left), addresses that concern in spades. When gluing up the walnut panel, I used the familiar pistol-grip to provide the initial clamping pressure, then really put the squeeze on by cranking the handle. This clamp puts as much bite on a workpiece as I've ever seen in a woodworking clamp.

It can provide this extra power because the Advantage clamp is made completely of steel, and you pay for it in more ways than one. The

added weight wore on me during a big, multiple-clamp glue-up. But, on the plus side, engineers also raised the jaw-travel-per-squeeze ratio about 60 percent over the original Quick-Grip clamp, so I didn't have to hold them as long while closing the jaws.

—Tested by Rich Bright

PRODUCT SCORECARD

Quick-Grip Advantage clamps

| | |
|-------------|--------------------------------|
| Performance | ★★★★★ |
| Price | \$50, 24"; \$45, 12"; \$42, 6" |
| Value | ★★★★☆ |

For more information call American Tool Company at 800/866-5740, or visit www.americantool.com.



Continued on page 102



“Glass showers” no longer in the forecast

Several years ago, when building a bed in my garage-shop, I got the surprise of my life when a shop light exploded. I was getting set to rip the bed rails when I accidentally swung the stock into the light fixture over my head, shattering the fluorescent tube and raining thousands of tiny glass pieces into my hair and down my shirt. Saf-T-Gard fluorescent tubes would have prevented that sudden shard shower.

Designed for use in restaurant salad bars where a shattered tube would pollute the entire menu, the Saf-T-Gard design features a standard glass envelope (bulb) surrounded by a 15-mil sealed polycarbonate wrap. If the bulb breaks, the glass and phosphors are completely captured by the wrap.

Using a slingshot, I fired small wooden blocks at the Saf-T-Gard tubes to simulate a kicked-back piece of stock. When I finally connected, I heard a muffled pop as the tube shattered, but no glass escaped. I then took another tube, and whacked it squarely against the corner of my workbench. This time, the tube bent at a 90° angle, but again, no explosion of glass shards.

At \$8 a pop for a 48” cool white Saf-T-Gard tube, they’re about four times the price of ordinary fluorescent tubes. But for shops with low ceilings, the peace of mind is worth the extra money.

—Tested by Dave Campbell



PRODUCT SCORECARD

Saf-T-Gard

Performance ★★★★★

Price \$8-12, 48” tube

Value ★★★★★

Call General Electric lighting at 800/435-2677, or visit www.gelighting.com.

It’s a bench, it’s a clamp, it’s Superjaws!

Superjaws may be the best thing to come out of Australia since the 2000 Summer Olympics. It has the strength of a weight lifter, but folds up like a gymnast. So what, exactly, is it?

Well, Superjaws is a shop aid that’s tough to categorize. Like a clamping workstation, its powerful jaws grip a workpiece for cutting or machining. However, where a clamping workstation has broad jaws that open several inches, Superjaws has a pair of narrow padded jaws that can hold almost anything up to 35” wide. To accomplish this, the movable, removable jaw flips end for end depending on how wide you need to clamp.

Instead of crank handles, Superjaws uses a foot pedal that you pump to close the jaws. I found this really handy when clamping large pieces, as I could use both hands to position and steady the workpiece. I had a mortise-and-tenon joint that dry-fit well, but when I applied glue, I couldn’t get it together for love nor money. I put the two pieces into Superjaws and used the foot pedal to press the joint together. No mallet, no marring.

I even mounted my portable planer to a plywood subbase and clamped it into Superjaws, as shown in the photo right. The wide stance of the legs kept the whole setup very stable, and, after running about 80 feet of stock through the planer, the jaws still held the machine rock-solid.

Folding and unfolding the stand is only a little more complicated than setting up a card table, and it took me less than 45 seconds each way. And at 44 pounds, you won’t want to carry it too far, but it stows smaller than other portable workstations.

—Tested by Garry Smith



PRODUCT SCORECARD

Superjaws

Performance ★★★★★

Price \$189

Value ★★★★★

For a retailer near you, call Triton Woodworking toll-free at 888/874-8661, or visit www.superjaws.com.

Sitka Spruce

the high flying wood of the Pacific Northwest

Alaska has great stands of Sitka spruce near the tree's namesake city in the southeastern part of the state. But even greater quantities grow along the coasts of British Columbia, Washington, and Oregon. And where it grows, this largest of all spruces in the Northern Hemisphere furnishes the paper-making industry the finest pulp. Yet, in days gone by, Sitka spruce played a nobler role, and in some cases, still does.

Of all the world's woods, Sitka spruce has the highest strength-to-weight ratio. Because of this, it was used in the manufacture of airplane frames during two world wars. Pound for pound stronger than steel, the light (about 25 pounds per

cubic foot, air-dry) straight-grained, shock-absorbing wood won't fracture as metal does. This trait makes Sitka spruce the perfect stock for propellers, too. However, it took old, slow-grown, tight-grained, knot- and blemish-free wood for aircraft construction. And those types of trees proved harder to find than aluminum and other manufactured materials, so production shifted away from the stately spruce.

It's in building construction that Sitka spruce finds its most useful employment today. The wood's toughness—combined with light weight—makes it ideal for extension ladders and scaffolding. The same qualities also make it great for

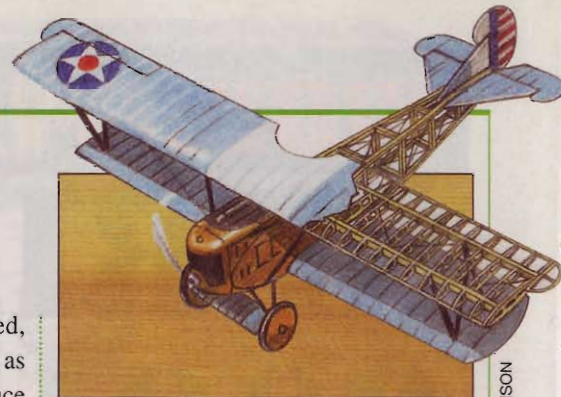

Airplanes with frames of Sitka spruce flew into combat during two world wars.

oars, paddles, and sailboat masts. And its ability to take and hold paint and stain place once high-flying Sitka spruce in a lofty position on the list for overhead garage doors.

To luthiers who build guitars and violins, the search for straight- and tight-grained Sitka spruce still goes on. That's because when sawn for vertical grain and used as soundboards, the wood represents a grand exchange for the effort that went into locating it.

ILLUSTRATION: JIM STEVENSON

Need more shop time?

PLUS, get \$10 off your first order!
Just enter code V1525 at checkout

Spend more time in your shop and less time shopping – when you order your hardware, supplies, and tools on-line.

Rockler.com
WOODWORKING SUPERSTORE

Circle No. 900

Econ-Abrasives
WE MAKE ABRASIVE BELTS ANY SIZE, ANY GRIT!

| Standard Abrasive Sheets | | | ABRASIVE BELTS | |
|--|---------|----------|--|------------|
| CABINET PAPER | | | Belts are resin bond cloth with a bi-directional splice, specify grits. | |
| | 50/pk | 100/pk | 1X30 | \$.81 ea |
| 60D | \$17.58 | \$31.58C | 3X24 | \$.93 ea |
| 80D | \$16.42 | \$29.26C | 1X42 | .81 ea |
| 100 thru 150C | \$15.26 | \$26.95C | 3X27 | .96 ea |
| FINISHING PAPER | | | 1X44 | .81 ea |
| 80A | \$11.74 | \$19.89C | 4X21 3/4 | 1.06 ea |
| 100 thru 280A | \$10.50 | \$17.58C | 2 1/2X16 | .85 ea |
| NO LOAD PAPER(white) | | | 4X24 | 1.10 ea |
| 100 thru 400A | \$12.90 | \$22.40C | 3X18 | .86 ea |
| "C" = 100 SHEETS | | | 4X36 | 1.35 ea |
| Velcro® Vacuum Discs | | | 3X21 | .90 ea |
| 8 Hole pattern for Bosch sanders | | | 6X48 | 3.50 ea |
| Dia. | Grit | Price | 3X23 3/4 | .93 ea |
| 5" | 60 | \$.48 ea | 6X89 | 6.24 ea |
| 5" | 80 | .46 | OTHER SIZES ON REQUEST | |
| 5" 100 thru 320 | .45 | | HEAVY DUTY SPRING CLAMPS | |
| * Available in 5 hole pattern * | | | Clamps come w/PVC tips and grips. | |
| *Wide Belts*Rolls*Flap Wheels | | | | Size Price |
| *Pump Sleeves*PSA Discs | | | 4" | \$1.75 ea |
| *Router & Wood Bits*Wood Glue | | | 6" | 2.25 |
| | | | 8" | 3.50 |
| | | | JUMBO ROUTER PAD(24" x 36") | |
| | | | It will not allow small blocks of wood to slip out under router or sanding applications. ROUTER PAD ONLY \$8.95ea. | |
| | | | JUMBO BELT CLEANING STICK | |
| | | | ONLY \$8.80 | |

*MasterCard, VISA, Discover, Am. Express
*SATISFACTION GUARANTEED!!!
*CALL FOR FREE CATALOG
-TX add appropriate sales tax
-Call for shipping charges

Econ-Abrasives
P. O. Box W1628
Frisco, TX 75034
(972)377-9779

TOLL-FREE ORDERING LINE (800)367-4101

Circle No. 1229

Aloha, woodworker

Approximately two million acres of land in Hawaii are forested, and they're the only tropical forests in the United States. Half of those acres are privately owned, according to the Hawaii Forest Industry Association.

Together, public and private forests sustain a \$30 million annual forest products industry. And while mainland woodworkers may be familiar with koa—the largest hardwood tree native to Hawaii—there are 18 other species frequently found in commercial quantities. Some, like Japanese cedar, Honduras mahogany, and Australian silky oak, were brought to the islands in the early 1900s to thrive, while in their native countries they've since become scarce.

For more interesting facts about and colorful photos of Hawaii's wood and resources, write for a colorful, 28-page *Resource Guide & Directory* (\$5 U.S. ppd.). Address your envelope to Hawaii Forest Industry Association, P.O. Box 10216, Hilo, HI 96721-9989. Or visit <http://hawaii-forest.org>. The Web site lists nearly 100 native and naturalized tree species found in Hawaii, and provides some interesting links.

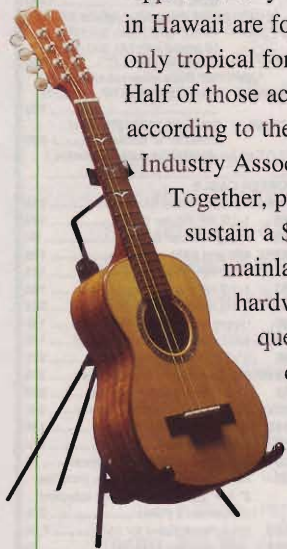

Ukuleles, like this one by David Gomes, are traditionally made from koa, which varies from tree to tree in color, figure, and grain texture.



Koa, the largest tree native to Hawaii, can grow to 100' tall with a trunk 6' in diameter.

All you ever wanted to know about hardwoods

The Hardwood Council wants to help you learn about native hardwoods. At its Web site (www.hardwoodcouncil.com), you can read about 21 species and where and how to use them. There's also a "Tips & Techniques" link covering 10 topics, such as installing flooring over concrete and making your own crown molding.

No internet link? For 10 free pamphlets on using hardwoods, write the Hardwood Council, P.O. Box 525, Oakmont, PA 15139. For answers to technical questions about hardwoods, call 412/281-4980.

Treated wood extends nation's forest resource

You probably never thought about it, but every time you use pressure-treated wood you're reducing the amount of wood that would otherwise be needed to replace decayed or termite-eaten stock, says the Southern Pine Council. It estimates that 6.5 billion board feet of wood—enough for 425,000 new homes—is conserved annually through the use of pressure-treated wood products.

Help for fire-ravaged forests

Five million acres of western forestland went up in smoke last year, making 2000 one of the worst years for fires in history, according to the U.S. Forest Service. (About 737 million forest acres are in the continental U.S.) Although wild fires can benefit a forest by jump-starting dormant seeds, many fires were so hot that they destroyed the seeds, too.

But help is on the way to get these forests growing again. The National Arbor Day Foundation's Trees for America program has for decades annually donated more than 8 million tree seedlings for members to plant across the nation. Now, special funding from members and corporations will enable foresters and volunteers to plant an additional 450,000 trees per year in fire-ravaged national forests. Planting seedlings, rather than waiting for natural reforestation, speeds recovery. Every \$1 contributed results in one planted seedling. To learn more, write Trees for America, National Arbor Day Foundation, P.O. Box 81412, Lincoln, NE 68501-1412, call 402/474-5655, or visit www.arboday.org/fires.



ROBERT SEMENIUK, THE STOCK MARKET

COURTESY OF THE HAWAII FOREST INDUSTRY ASSOC.